

KRTS-4-T Shut-off and regulating damper

Dampers for shut-off and regulating of air flow in round smoke duct systems.
 KRTS-4-T sealed version. Casing tightness class C and shut-off tightness class 4 (standard EVS-EN 1751:2014).



Structure and dimensions

Manufactured of galvanized steel. Equipped with rubber gaskets. Can also be manufactured of zinc-magnesium coated steel (ZM310).
 For manual regulation, there is a handle installed.

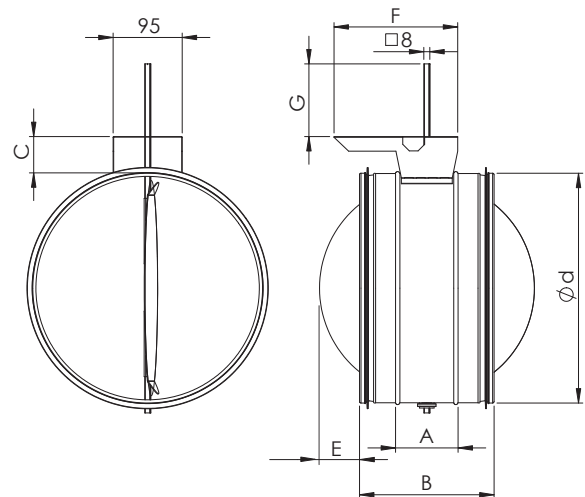

| Size | A | B | C | E | F | G | Min torque | Weight, kg |
|------|-----|-----|----|-----|-----|-----|------------|------------|
| 100 | 95 | 155 | 30 | - | 170 | 100 | 2 | 0,6 |
| 125 | 95 | 155 | 38 | - | 170 | 100 | 2 | 0,7 |
| 160 | 95 | 155 | 45 | - | 170 | 100 | 2 | 0,9 |
| 200 | 95 | 155 | 30 | 15 | 170 | 116 | 2 | 1,1 |
| 250 | 117 | 215 | 36 | 10 | 170 | 113 | 4 | 1,6 |
| 315 | 117 | 215 | 40 | 43 | 170 | 110 | 4 | 2,1 |
| 400 | 117 | 215 | 43 | 85 | 170 | 109 | 4 | 3,2 |
| 500 | 125 | 255 | 46 | 115 | 255 | 108 | 10 | 4,7 |
| 630 | 125 | 255 | 48 | 180 | 225 | 107 | 10 | 6,3 |

Technical data

KRTS-4-T, shut-off tightness class 4

KRTS-4-T 100

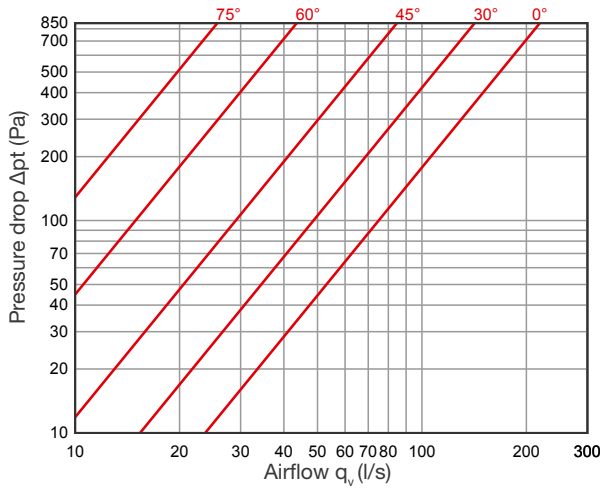

KRTS-4-T 125

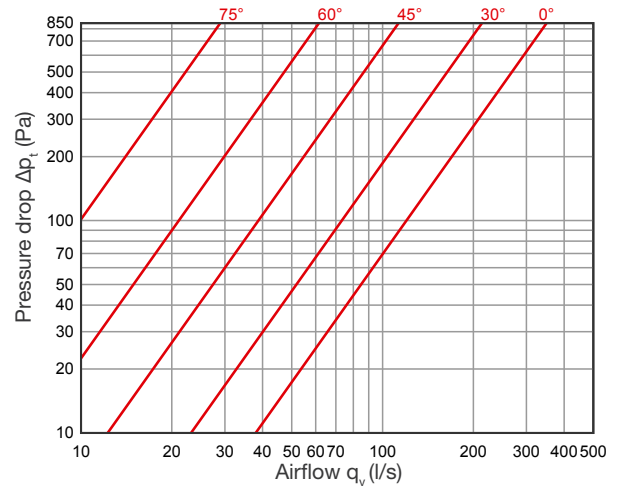

KRTS-4-T 160

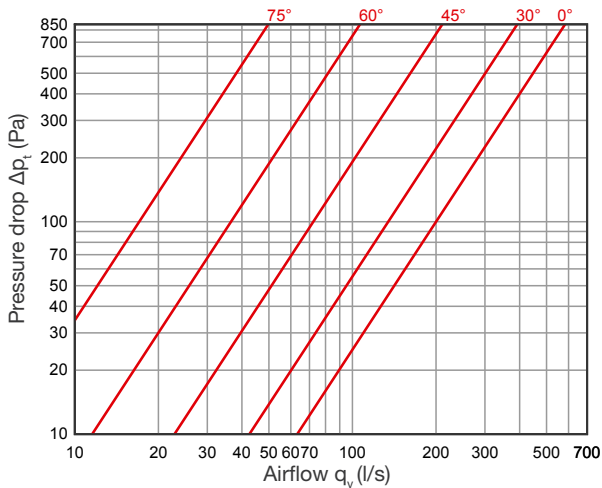

KRTS-4-T 200

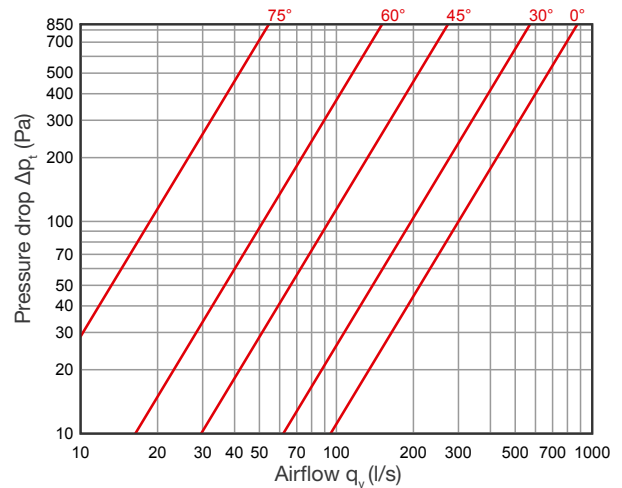

KRTS-4-T 250

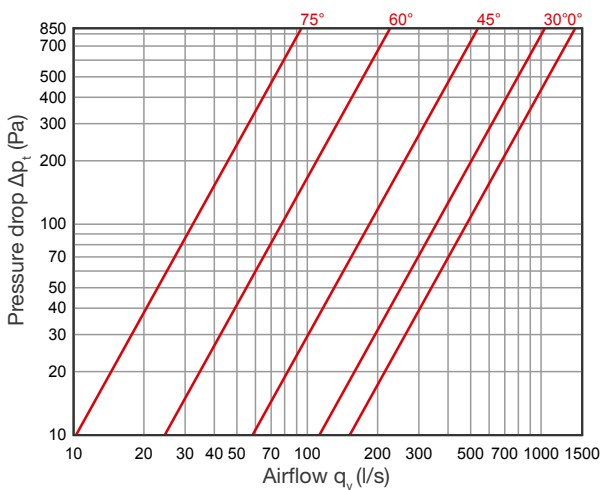

KRTS-4-T 315

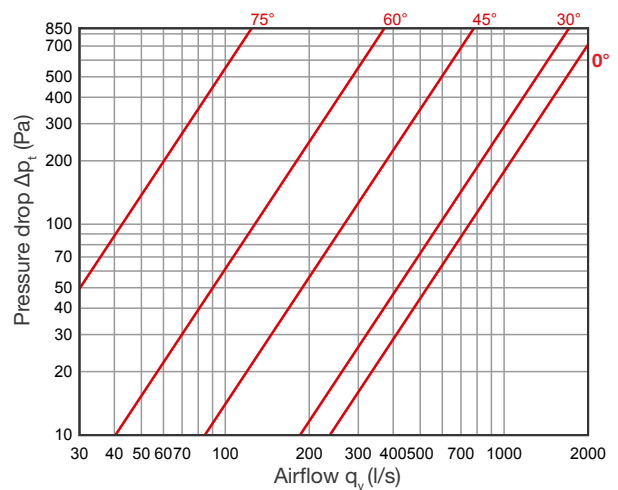

KRTS-4-T 400

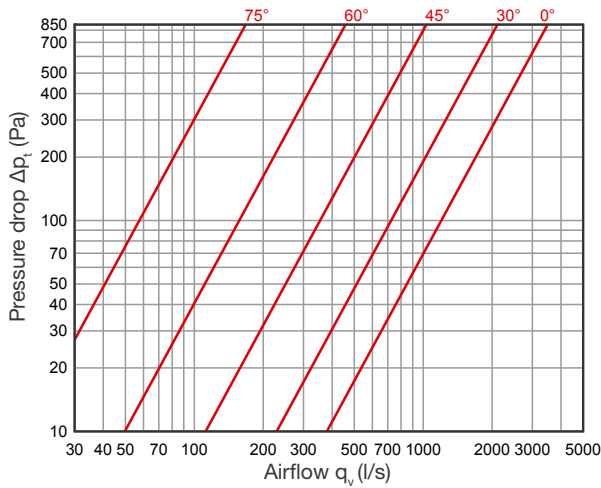

KRTS-4-T 500

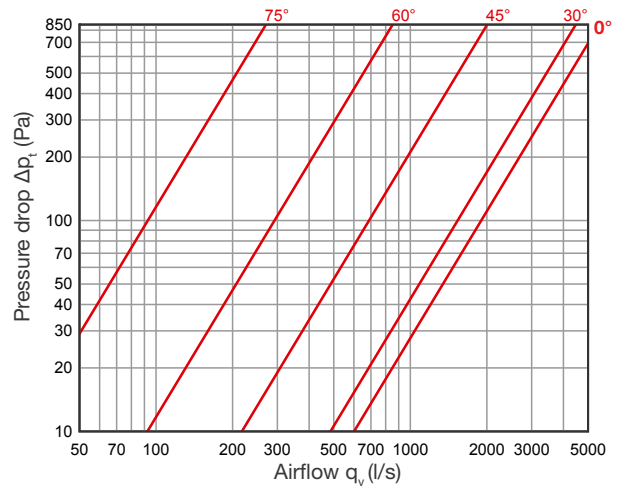

KRTS-4-T 630

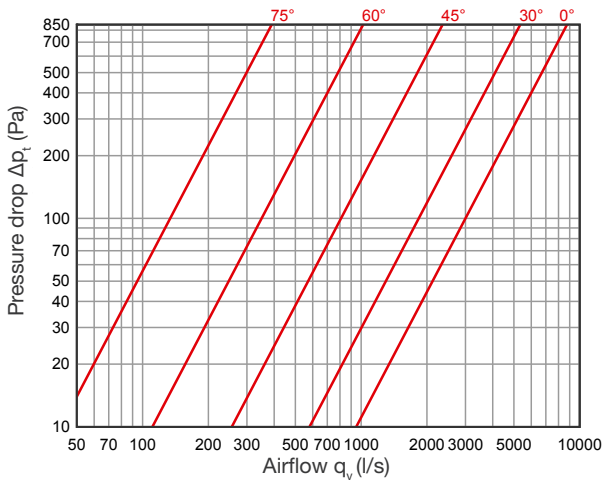

Product code

KRTS-4-T - ZM - d

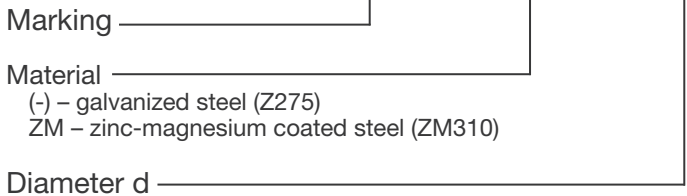

(-) – galvanized steel (Z275)
 ZM – zinc-magnesium coated steel (ZM310)

Example: KRTS-4-T 315