

DEN Diffuser for supply air

Supply air diffuser with round plenum box for visible installation.

Features:

- visible installation
- duct sizes Ø 100-315 mm
- easy to clean
- low noise level
- with measuring and regulating device

Air jets through the side and perforated front plate. Easily removable front plate makes cleaning easy.



Material and sizes

Manufactured of galvanized steel and coated with white (RAL 9003) polyester powder coating. Round duct connection with rubber gasket.

Nominal size	Ød	ØA	B	E	Weight, kg
100	99,3	350	240	36	2,5
125	124,3	350	240	38	3,0
160	159,3	400	275	41	4,5
200	199,3	450	305	31	7,2
250	249,3	500	395	56	11,0
315	314,3	600	487	56	12,0

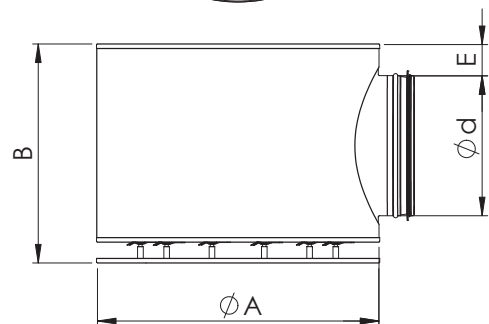
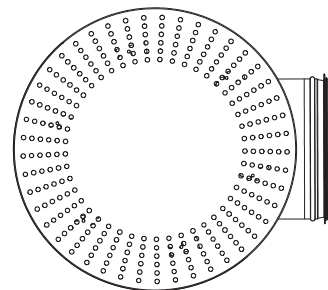

Technical data

DEN 100

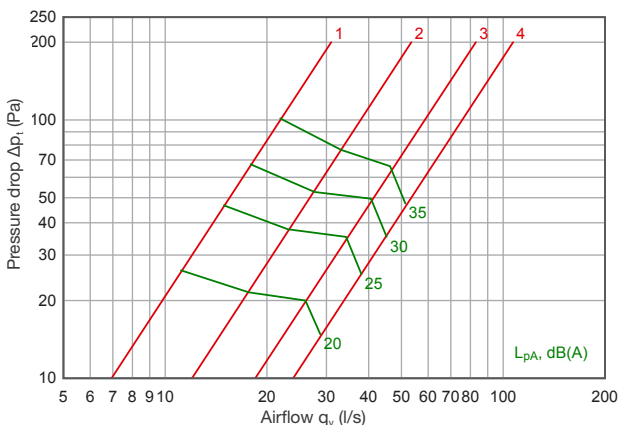

DEN 125

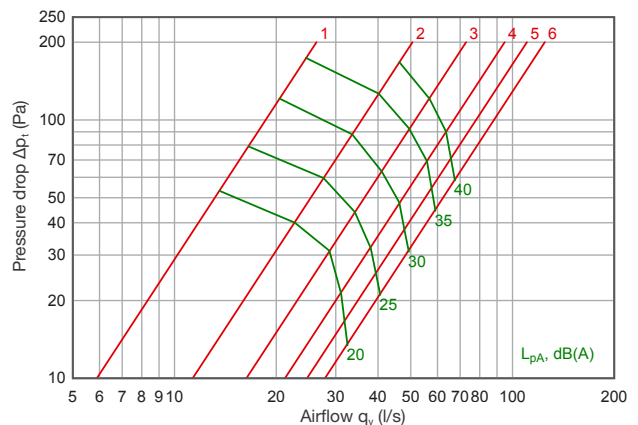

DEN 160

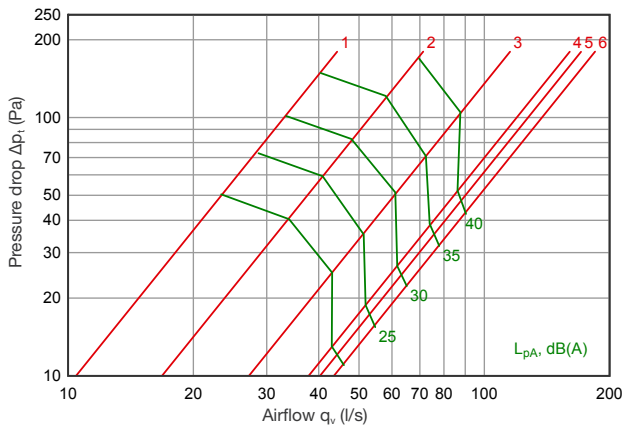

DEN 200

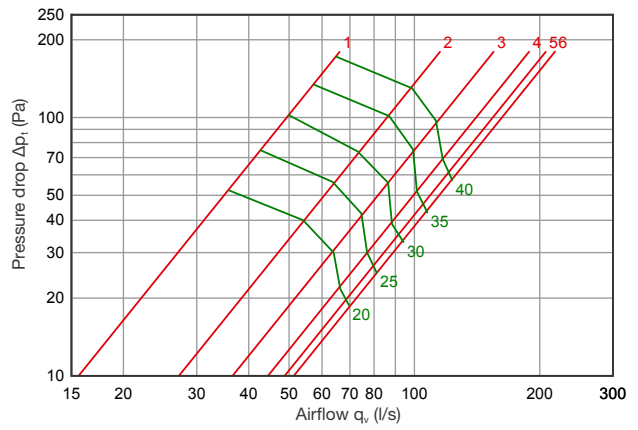

DEN 250

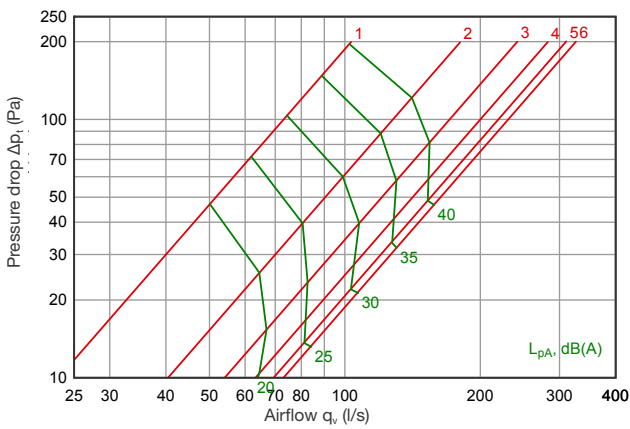

DEN 315

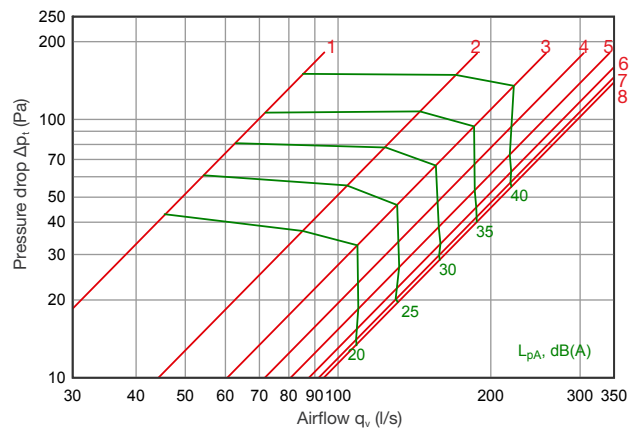

Throw

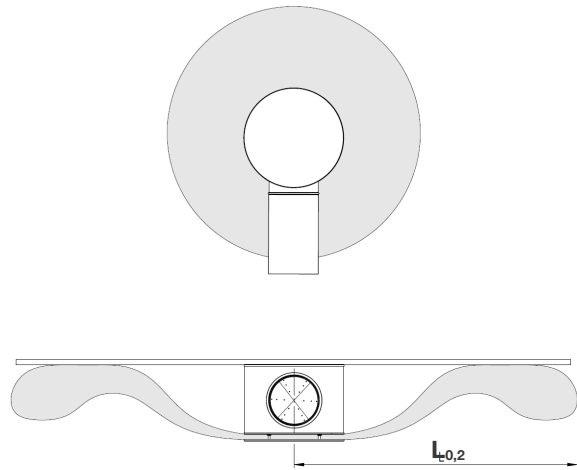
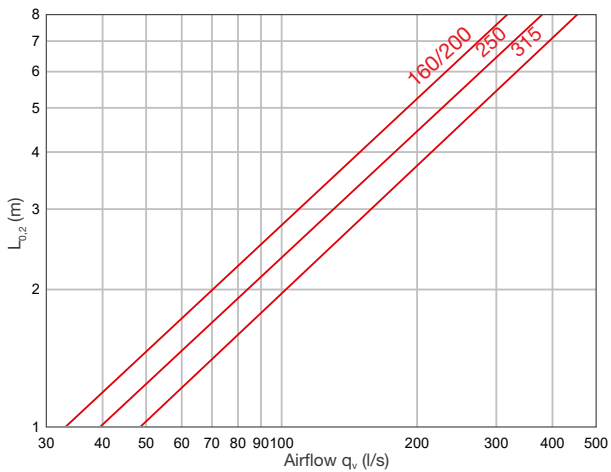

K-factor

Nominal size	Position							
	1	2	3	4	5	6	7	8
DEN 100	2,2	3,7	5,4	6,7				
DEN 125	1,85	3,65	5,35	7,25	8,60	9,80		
DEN 160	3,3	5,6	9,1	13	14,7	17		
DEN 200	5,2	10	15,1	21,3	26,1	29,3		
DEN 250	8,7	16,6	24,2	33,7	40,6	43,5		
DEN 315	7,8	18	27,9	36,1	47,5	56,5	86,4	91,3

Product codes

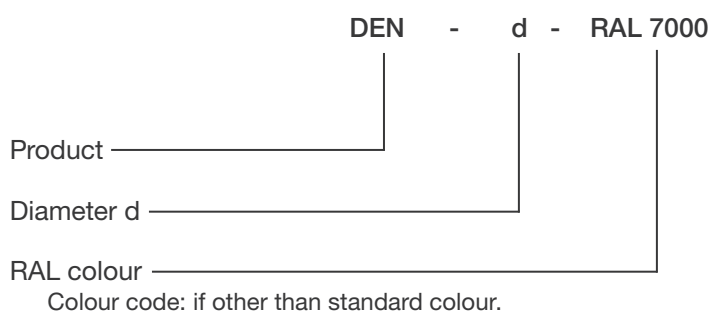

Example: DEN 200
 DEN 200 RAL7000