



## NORDdamper

### RPMC-K kandiline mõõte- ja reguleeriseade

Seade konstantsete õhuhulkade reguleerimiseks ventilatsioonisüsteemides

Nimimõõt 200×100 ... 600×600

Õhuhulgad 250 ... 12 000 m<sup>3</sup>/h (69 ... 3333 l/s)

Korpuse tihedusklass C vastavalt standardile EN 1751

Materjal kuumtsingitud terasleht

## Sisukord

1. Kirjeldus	3
2. Konstruksioon	3
3. Mõõdud	4
4. Paigaldamine	6
5. Tehnilised andmed	7
5.1 Ühendskeemid	9
5.2 Rõhukadu	10
6. Mõõda andmed	11
6.1 Isoleerimata klapi mõõda	24
6.2 Isoleeritud klapi mõõda	30
7. Kontrollimine ja testimine	36
8. Transport ja ladustamine	36
9. Markeerimine	36

## Üldist

### 1. Kirjeldus

Konstantse õhuvoolu klapid on mõeldud kasutamiseks süsteemides, mille oluliseks osaks on sissepuhke või väljatõmbeõhu reguleerimine. Klapid sobivad paigaldamiseks nii horisontaalsesse kui ka vertikaalsesse asendisse. Voolu mõjul regulaatori labale mõjuvad aerodünaamilised jõud tasakaalustatakse vastavalt nõutavale vooluhulgale seadistatud juhtseadmega.

Vajalik õhuhulk seadistatakse käsijuhtimishoova osuti ja skaala abil. Mehhaaniliselt juhitud klapp ei pea olema ühendatud ühegi välise toiteallikaga.

Klappide tõrgeteta töö on tagatud järgmistel tingimustel:

- maksimaalne õhuvoolu kiirus 10 m/s;
- maksimaalne rõhk torustikus 1000 Pa;
- õhuringlus peab klapis tervikuna olema kogu pindala suhtes ühtlane.

RPMC-K reguleerseade koosneb korpusest koos juhtlabaga ja juhtseadmega. Juhtseade on paigutatud karbi sisse koos skaalaga vajaliku voolu reguleerimiseks. Seadme täpsus on  $\pm 5\%$ .

Klapid on projekteeritud mõõduka kliimaga piirkondade jaoks vastavalt standardile EN 60 721-3-3. Klapid sobivad kasutamiseks süsteemides, milles ei ole abrasiivseid, keemilisi ega kleepuvaid osakesi. Temperatuur klapi asukohas on lubatud vahemikus 0 °C kuni +50 °C.

### 2. Konstruktsioon

RPMC-K reguleerseade koosneb korpusest, labast ja juhtseadmest. Juhtseade koosneb vedrust ja amortisaatorist. Juhtseade töötab käsijuhtimishoovaga, mille kasutamisel saab skaalalt valida soovitud õhuhulga.

Klapi korpus ja juhtseadme osad on valmistatud kuumtsingitud teraslehest. Laba on valmistatud alumiiniumlehest, Laba laagrid on plastikust. Klapi telg ja vedru on valmistatud roostevabast terasest

Klapid tarnitakse ilma täiendava pinnatöötluseta.

Vastavalt kliendi soovile võib klapp olla valmistatud ka roostevabast materjalist (AISI 304).

Klappe on võimalik tarnida ka koos ajamiga. See võimaldab vajaliku õhuhulga kaugjuhtimist. Sellisel juhul ei kontrolli ajam klapi laba, vaid hoova asendit õhuhulga reguleerimiseks. Ajami kasutustemperatuuri vahemik peab jääma 0 °C kuni + 50 °C vahele.

Toodet võib tellida ka isoleeritud kujul.

Isoleerimata klapp

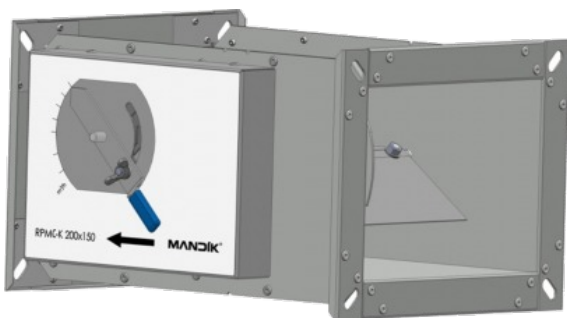

Isoleeritud klapp

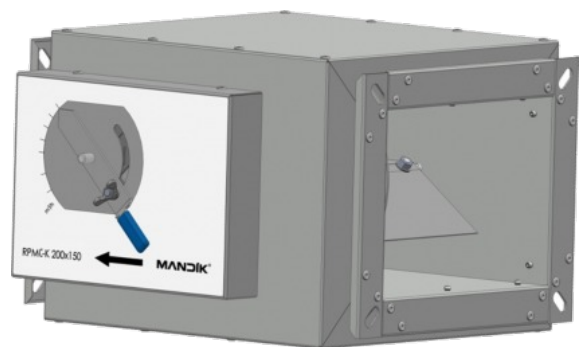

**3. Mõõdud ja kaal**

**RPMC-K – mehaaniline**

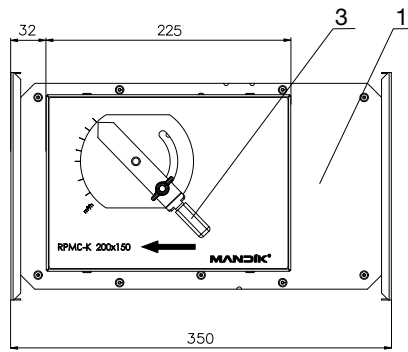
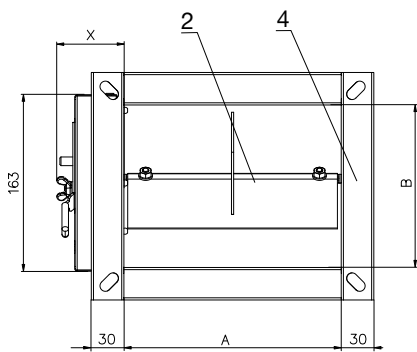

- 1 - Klapi korpus
- 2 - Klapi laba
- 3 - Käsijuhtimishoob
- 4 - Ühendusprofiil

**RPMC-K – mehaaniline, isoleeritud**

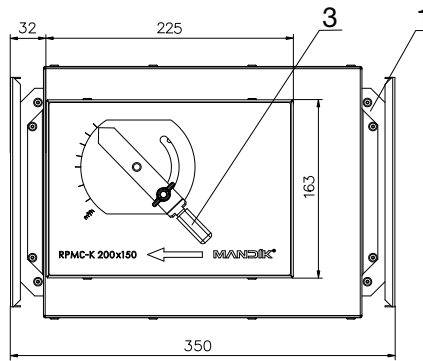
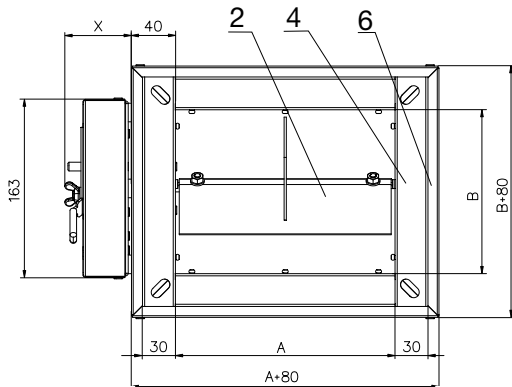

- 1 - Klapi korpus
- 2 - Klapi laba
- 3 - Käsijuhtimishoob
- 4 - Ühendusprofiil
- 6 – Isolatsioonikest

**RPMC-K – ajamiga**

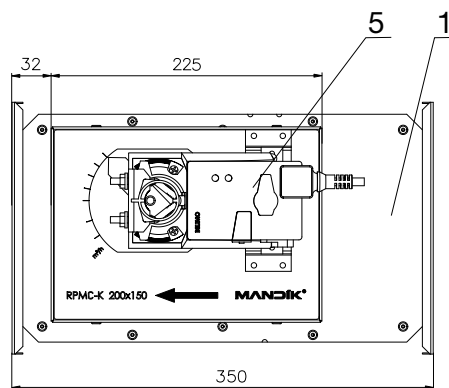
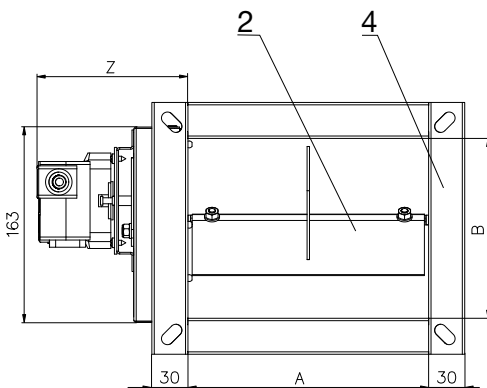

- 1 - Klapi korpus
- 2 - Klapi laba
- 4 - Ühendusprofiil
- 5 – Ajam

**RPMC-K – B ≥ 400 mehaaniline**

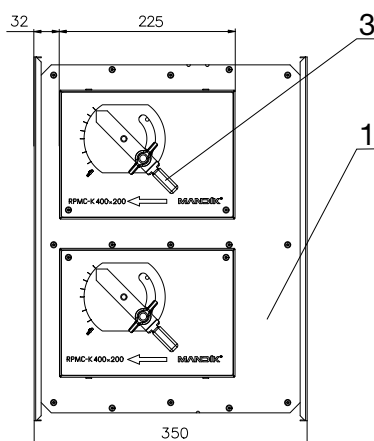
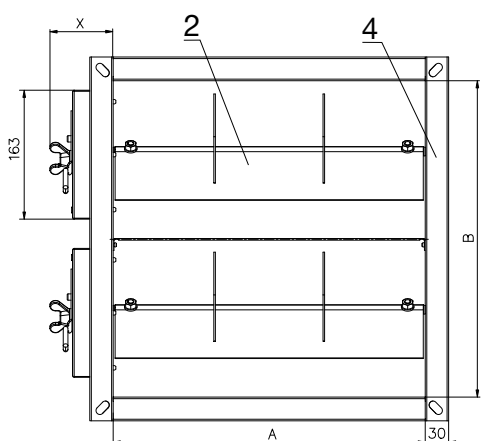

- 1 - Klapi korpus
- 2 - Klapi laba
- 3 - Käsijuhtimishoob
- 4 - Ühendusprofiil

Tabel 1. RPMC-K reguleerseadme mõõdud ja kaal

Nimimõõt A x B (mm)	X	Z	Kaal (kg)				Ajam
			Mehaaniline		Ajamiga		
			Isoleerimata	Isoleeritud	Isoleerimata	Isoleeritud	
200 x 100	62	125	3,97	6,10	4,63	6,76	LM
200 x 150	62	125	4,36	6,74	5,01	7,40	LM
200 x 200	62	125	4,79	7,43	5,45	8,09	LM
300 x 100	62	125	4,69	7,32	5,35	7,98	LM
300 x 150	62	125	5,15	8,03	5,80	8,69	LM
300 x 200	62	125	5,55	8,68	6,21	9,34	LM
300 x 250	62	125	5,96	9,35	6,62	10,01	NM
300 x 300	81	132	6,47	10,11	7,43	11,07	NM
400 x 200	81	132	6,38	10,02	7,04	10,68	LM
400 x 250	87	137	6,88	10,77	7,84	11,73	NM
400 x 300	81	132	7,93	12,06	8,88	13,02	NM
400 x 400	* 81	132	10,70	15,34	12,61	17,25	NM
500 x 200	81	132	7,19	11,32	8,15	12,28	NM
500 x 250	87	137	8,77	13,15	9,73	14,11	NM
500 x 300	120	170	9,95	14,58	11,10	15,74	SM
500 x 400	* 81	132	12,00	17,14	13,92	19,06	NM
500 x 500	* 87	137	15,17	20,81	17,08	22,72	NM
600 x 200	120	170	9,60	14,23	10,75	15,39	SM
600 x 250	120	170	10,26	15,15	11,42	16,31	SM
600 x 300	120	170	10,88	16,02	12,04	17,18	SM
600 x 400	*120	170	16,48	22,12	18,80	24,44	SM
600 x 500	*120	170	17,81	23,95	20,13	26,27	SM
600 x 600	*120	170	19,06	25,70	21,37	28,01	SM

\* Alates mõõdust B≥400 paigaldatakse kaks kõrvuti asetsevat kontrolleri ühe klapi peale. Soovitud õhuhulk on kahe kontrolleri õhuhulga summa. Kontrolleriid on varustatud kahe eraldi seisva mehaanilise juhtseadme või ajamiga.

#### 4. Paigaldamine

Klapid on mõeldud paigaldamiseks ventilatsioonitorustikku. Töösens on horisontaalne või vertikaalne koos horisontaalse labateljega.

Klapp paigaldada sõltuvalt õhuvoolu suunast (tähistatud noolega juhtseadme alusel).

Klappide paigaldamisel järgida kõiki kehtivaid ohutuslaseid standardeid ja direktiive.

Klapp töötab laitmatult kui õhuringlus klapis tervikuna on kogu pindala suhtes ühtlane. Vahemaa klapi ja kanalisad vahel (põlved, hargnemised jne) peab olema minimaalselt 2xU (kolmikuga ühendamisel) ja 1xU (põlvega ühendamisel).

Klapi korpus ei tohi paigalduse käigus saada vigastada..

##### Soovitav kaugus kolmikühendusest

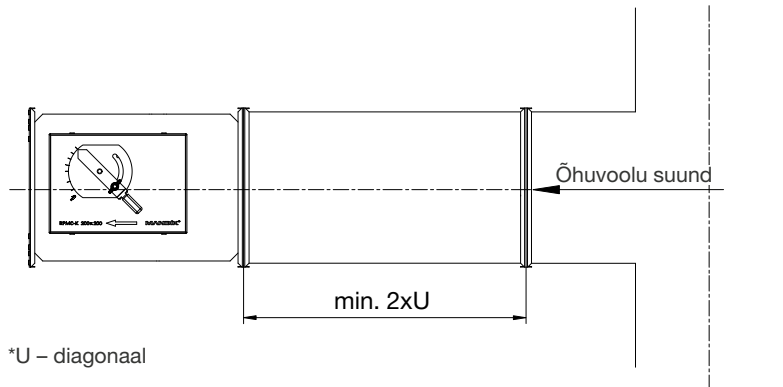

##### Soovitav kaugus põlvühendusest

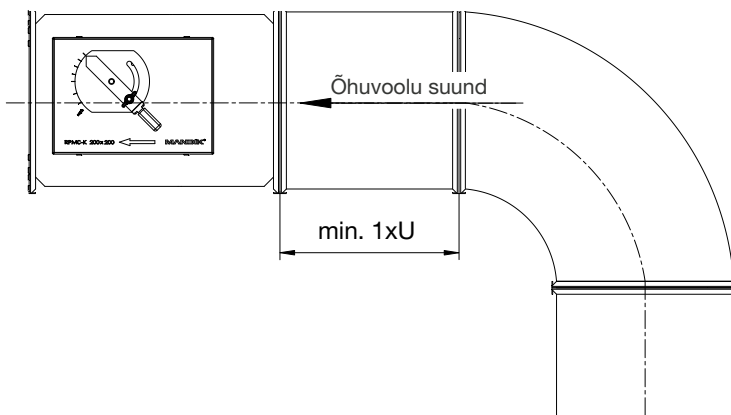

Klapi ühendusprofiil on mõeldud ühendamiseks 30 mm kanali ühendusliistuga. Ühendusprofiili nurkades on ovaalsed avad.

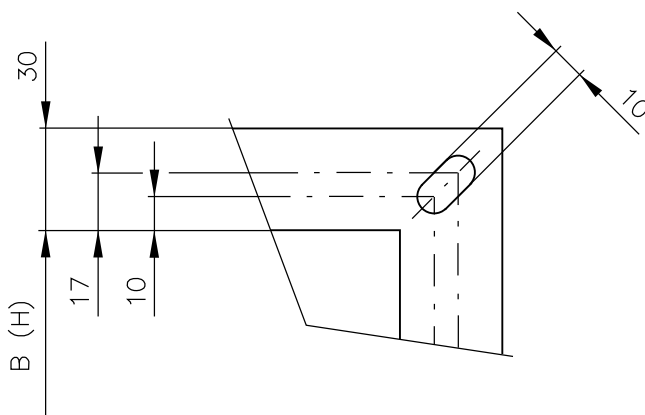

## 5. Tehnilised andmed

Tabel 2. Minimaalne ja maksimaalne õhu

Nimimõõt A x B (mm)	Õhuhulk (m <sup>3</sup> /h)		Õhuhulk (l/s)		Nimimõõt A x B (mm)	Õhuhulk (m <sup>3</sup> /h)		Õhuhulk (l/s)	
	min.	maks.	min.	maks.		min.	maks.	min.	maks.
200 x 100	250	700	69	194	500 x 200	1100	3400	306	944
200 x 150	400	1000	111	278	500 x 250	1500	4200	417	1167
200 x 200	500	1300	139	361	500 x 300	1800	4800	500	1333
300 x 100	400	1000	111	278	500 x 400	2200	6800	611	1889
300 x 150	500	1500	139	417	500 x 500	3000	8400	833	2333
300 x 200	600	2000	167	556	600 x 200	1500	4000	417	1111
300 x 250	800	2500	222	694	600 x 250	1800	5000	500	1389
300 x 300	1000	3000	278	833	600 x 300	2100	6000	583	1667
400 x 200	900	2700	250	750	600 x 400	3000	8000	833	2222
400 x 250	1200	3400	333	944	600 x 500	3600	10000	1000	2778
400 x 300	1500	4200	417	1167	600 x 600	4200	12000	1167	3333
400 x 400	1800	5400	500	1500					

Tabel 3. Reuleerseadme tehnilised andmed

Nimimõõt	Õhuhulk		Maks. täpsus (%)	Min. rõhuvahe (Pa)	Nimimõõt	Õhuhulk		Maks. täpsus (%)	Min. rõhuvahe (Pa)
	(m <sup>3</sup> /h)	(l/s)				(m <sup>3</sup> /h)	(l/s)		
200 x 100	250	69	20	70	300 x 150	500	139	20	70
	400	111	15	70		800	222	15	70
	500	139	15	70		1000	278	10	70
	700	194	10	80		1500	417	10	70
200 x 150	400	111	20	70	300 x 200	600	167	20	70
	600	167	15	70		800	222	15	70
	800	222	15	70		1200	333	15	80
	1000	278	10	80		2000	556	10	80
200 x 200	500	139	20	70	300 x 250	800	222	20	70
	700	194	15	70		1200	333	15	70
	1000	278	10	70		1700	472	10	80
	1300	361	10	80		2500	694	10	80
300 x 100	400	111	20	70	300 x 300	1000	278	20	70
	600	167	15	70		1500	417	15	70
	800	222	10	70		2000	556	15	80
	1000	278	10	80		3000	833	10	90
400 x 200	900	250	20	70	500 x 500	3000	833	20	70
	1500	417	15	70		5000	1389	15	70
	2000	556	10	70		7000	1944	15	80
	2700	750	10	70		8400	2333	10	90
400 x 250	1200	333	20	70	600 x 200	1500	417	20	70
	1600	444	15	70		2000	556	15	70
	2500	694	15	70		3000	833	15	70
	3400	944	10	80		4000	1111	10	80

Nimimõõt	Õhuhulk		Maks. täpsus (%)	Min. rõhuvahe (Pa)	Nimimõõt	Õhuhulk		Maks. täpsus (%)	Min. rõhuvahe (Pa)
	(m³/h)	(l/s)				(m³/h)	(l/s)		
400 x 300	1500	417	20	70	600 x 250	1800	500	20	70
	2500	694	15	70		2500	694	15	70
	3500	972	15	70		3500	972	15	80
	4200	1167	10	90		5000	1389	10	80
400 x 400	1800	500	20	70	600 x 300	2100	583	20	70
	3000	833	15	70		3500	972	15	70
	4000	1111	10	70		4500	1250	10	80
	5400	1500	10	70		6000	1667	10	80
500 x 200	1100	306	20	70	600 x 400	3000	833	20	70
	1500	417	15	70		4000	1111	15	70
	2500	694	15	70		6000	1667	15	70
	3400	944	10	80		8000	2222	10	80
500 x 250	1500	417	20	70	600 x 500	3600	1000	20	70
	2500	694	15	70		5000	1389	15	70
	3500	972	15	80		7000	1944	15	80
	4200	1167	10	90		10000	2778	10	80
500 x 300	1800	500	20	70	600 x 600	4200	1167	20	70
	2500	694	15	70		7000	1944	15	70
	3500	972	15	80		9000	2500	10	80
	4800	1333	10	90		12000	3333	10	80
500 x 400	2200	611	20	70					
	3000	833	15	70					
	5000	1389	15	70					
	6800	1889	10	80					

Tabel 4. Ajamite tehnilised andmed

Ajam	Asendi tähis	Pöörde-moment	Kaal (kg)	Nimipinge	Võimsustarve		
					Töös	Oote-režiimis	Suurus-mõõt
Belimo LM 230A	NO	5 Nm	0,50	AC 100 ... 240 V, 50/60 Hz	1,5 W	0,4 W	4 VA
Belimo LM 230A-S	YES	5 Nm	0,60	AC 100 ... 240 V, 50/60 Hz	1,5 W	0,4 W	4 VA
Belimo NM 230A	NO	10 Nm	0,75	AC 100 ... 240 V, 50/60 Hz	2,5 W	0,6 W	5,5 VA
Belimo NM 230A-S	YES	10 Nm	0,85	AC 100 ... 240 V, 50/60 Hz	2,5 W	0,6 W	6 VA
Belimo LM 24A	NO	5 Nm	0,50	AC 24 V, 50/60 Hz; DC 24 V	1 W	0,2 W	2 VA
Belimo LM 24A-S	YES	5 Nm	0,60	AC 24 V, 50/60 Hz; DC 24 V	1 W	0,2 W	2 VA
Belimo NM 24A	NO	10 Nm	0,75	AC 24 V, 50/60 Hz; DC 24 V	1,5 W	0,2 W	3,5 VA
Belimo NM 24A-S	YES	10 Nm	0,85	AC 24 V, 50/60 Hz; DC 24 V	1,5 W	0,2 W	4 VA
Belimo LM 24A-SR	YES	5 Nm	0,85	AC 24 V, 50/60 Hz; DC 24 V	1,0 W	0,4 W	2 VA
Belimo NM 24A-SR	YES	10 Nm	0,80	AC 24 V, 50/60 Hz; DC 24 V	2,0 W	0,4 W	4 VA
Belimo SM 230A	NO	20 Nm	1,05	AC 100 ... 240 V, 50/60 Hz	2,5 W	0,6 W	6 VA
Belimo SM 230A-S	YES	20 Nm	1,10	AC 100 ... 240 V, 50/60 Hz	2,5 W	0,6 W	6 VA
Belimo SM 24A	NO	20 Nm	1,00	AC 24 V, 50/60 Hz; DC 24 V	2,0 W	0,2 W	4 VA
Belimo SM 24A-S	YES	20 Nm	1,05	AC 24 V, 50/60 Hz; DC 24 V	2,0 W	0,2 W	4 VA
Belimo SM 24A-SR	YES	20 Nm	1,05	AC 24 V, 50/60 Hz; DC 24 V	2,0 W	0,4 W	4 VA



### 5.1 Ühenduskeemid

#### Belimo ajam LM (NM, SM) 230A

**Märkused:**

- Ettevaatust: toitepinge! 
- Võimalik on paralleelühendus teise ajamiga.
- Pöörake tähelepanu toitesisendi andmetele.

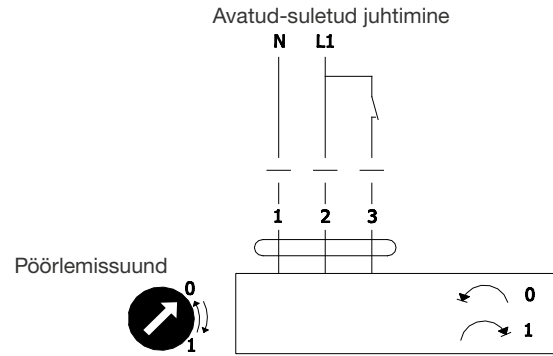

#### Belimo ajam LM (NM, SM) 24A

**Märkused:**

- Ühendus läbi eraldustrafo. 
- Võimalik on paralleelühendus teise ajamiga.
- Pöörake tähelepanu toitesisendi andmetele.

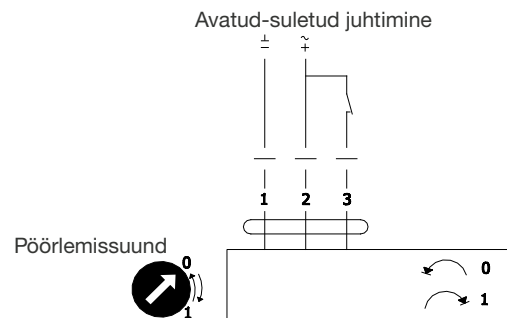

#### Belimo ajam NM (SM) 24A-SR

**Märkused:**

- Ühendus läbi eraldustrafo. 
- Võimalik on paralleelühendus teise ajamiga.
- Pöörake tähelepanu toitesisendi andmetele.

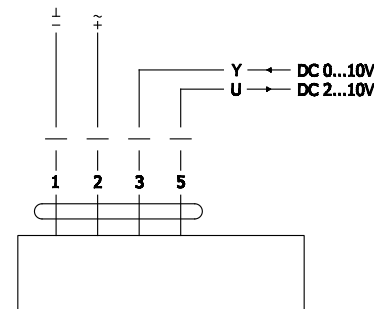

#### Belimo ajam LM (NM, SM) 230A-S

**Märkused:**

- Ettevaatust: toitepinge! 
- Võimalik on paralleelühendus teise ajamiga.
- Pöörake tähelepanu toitesisendi andmetele

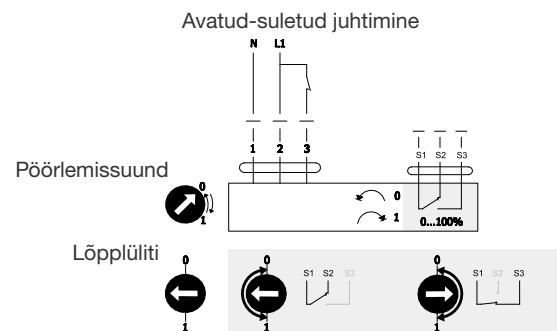

#### Belimo ajam LM (NM, SM) 24A-S

**Märkused:**

- Ühendus läbi eraldustrafo. 
- Võimalik on paralleelühendus teise ajamiga.
- Pöörake tähelepanu toitesisendi andmetele.

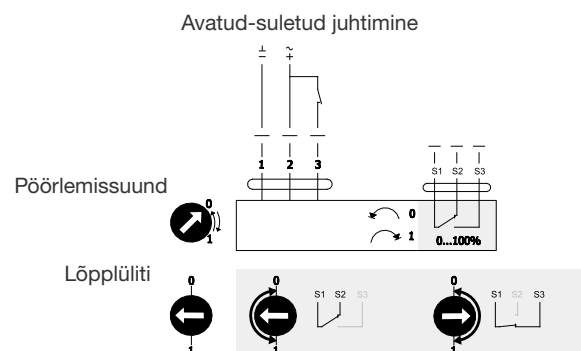

## 5.2 Rõhukadu

Väärtused kehtivad juhul, kui klapi laba on täielikult avatud..

### Rõhukao leidmine

$$\Delta p = \xi * \rho * (v^2 / 2)$$

$\Delta p$  – rõhukadu (Pa)

$\xi$  – kohalik takistustegur (vt. tabelist)

$\rho$  – õhutihedus (kg/m<sup>3</sup>) (õhutiheduse  $\rho=1,2$  kg/m<sup>3</sup>)

$v$  – õhu kiirus (m/s)

Nimimõõt A x B (mm)	$\xi$	Nimimõõt A x B (mm)	$\xi$	Nimimõõt A x B (mm)	$\xi$
200 x 100	1,386	400 x 200	1,344	500 x 500	1,224
200 x 150	1,379	400 x 250	1,330	600 x 200	1,316
200 x 200	1,372	400 x 300	1,316	600 x 250	1,295
300 x 100	1,379	400 x 400	1,288	600 x 300	1,274
300 x 150	1,368	500 x 200	1,330	600 x 400	1,231
300 x 200	1,358	500 x 250	1,312	600 x 500	1,189
300 x 250	1,347	500 x 300	1,295	600 x 600	1,147
300 x 300	1,337	500 x 400	1,260		

### Rõhukao diagramm

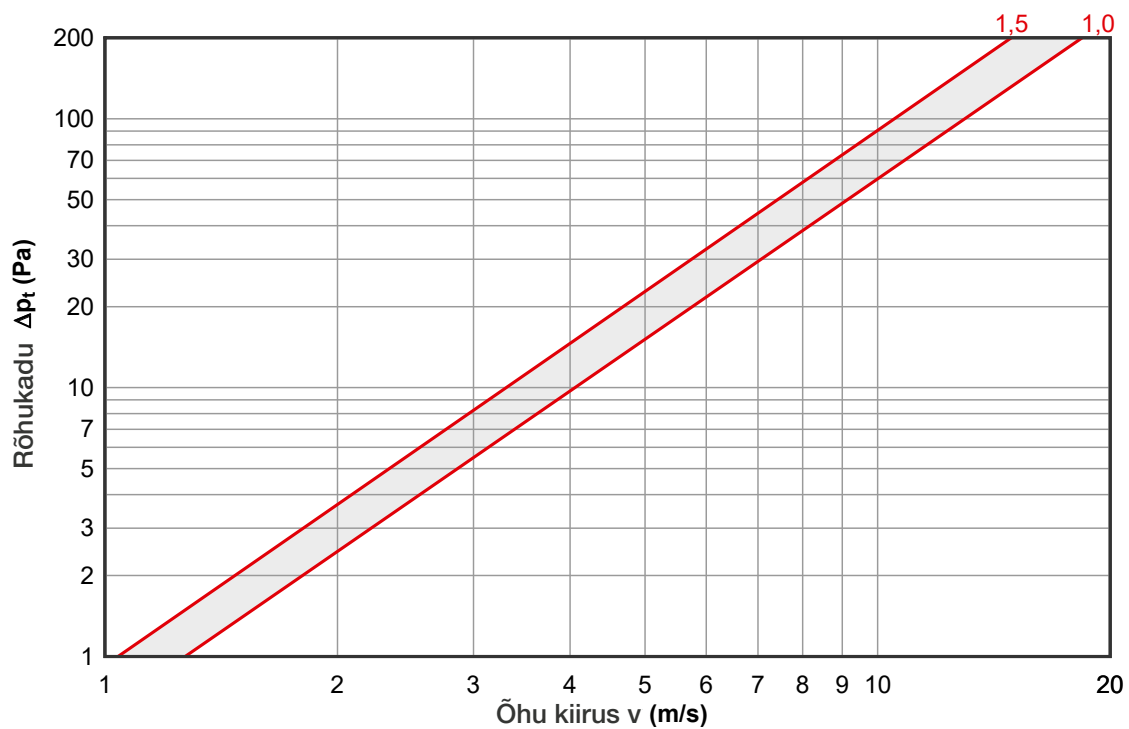

## 6. Mõõra andmed

Mõõra väärtused klapis on välja toodud alljärgnevas tabelites.

$q_v$  (m<sup>3</sup>/h; l/s) – õhuhulk

$L_{WA}$  [dB(A)] – A filtriga korrigeeritud helivõimsuse tase

$\Delta p_{st}$  (Pa) – rõhuvähe

$L_w$  (dB/Okt.) – helivõimsuse tase oktaavribades

$f_m$  (Hz) – average frequency of the octave band

Tabel 5. Mõõra väärtused klapis 50 Pa rõhukao korral

Nimimõõt (mm)	$q_v$		$\Delta p_{st} = 50 \text{ Pa}$								$L_{WA}$ (dB(A))
			$L_w$ (dB/Okt.)								
	m <sup>3</sup> /h	l/s	63	125	250	500	1000	2000	4000	8000	
200 × 100	250	69	39	38	34	34	35	36	35	33	42
	400	111	44	43	41	40	39	41	41	38	47
	550	153	43	45	44	43	45	43	44	40	50
	700	194	47	46	47	47	48	46	47	41	53
200 × 150	400	111	42	41	37	37	37	38	38	35	44
	600	167	44	43	42	43	42	42	42	39	49
	800	222	45	46	45	45	46	45	46	43	52
	1000	278	49	49	48	48	49	48	48	44	55
200 × 200	500	139	42	41	37	37	37	38	38	35	44
	765	213	45	44	42	41	40	42	42	39	48
	1035	288	44	46	47	46	46	44	44	38	51
	1300	361	47	46	47	48	48	47	47	39	54
300 × 100	400	111	45	44	40	40	40	41	41	38	47
	600	167	48	47	45	44	43	45	45	42	51
	800	222	48	50	51	50	50	48	48	42	55
	1000	278	51	50	51	52	52	51	51	43	58
300 × 150	500	139	42	41	37	37	37	38	38	35	44
	835	232	46	45	43	42	41	43	43	40	49
	1165	324	47	49	50	49	49	47	47	41	54
	1500	417	51	50	51	52	52	51	51	43	58
300 × 200	600	167	44	43	39	39	39	40	40	37	46
	1065	296	47	46	44	43	42	44	44	41	50
	1535	426	47	49	50	49	49	47	47	41	54
	2000	556	52	51	52	53	53	52	52	44	59
300 × 250	800	222	45	44	40	40	40	41	41	38	47
	1365	379	49	47	45	44	43	45	45	42	51
	1935	538	48	50	51	50	50	48	48	42	55
	2500	694	51	50	51	52	52	51	51	43	58
300 × 300	1000	278	45	44	40	40	40	41	41	38	47
	4665	1296	48	47	45	44	43	45	45	42	51
	2335	649	48	50	51	50	50	48	48	42	55
	3000	833	51	50	51	52	52	51	51	43	58

$\Delta p_{st} = 50 \text{ Pa}$											
Nimimõõt (mm)	$q_v$		$L_w$ (dB/Okt.)								$L_{WA}$ (dB(A))
			$f_m$ (Hz)								
	$\text{m}^3/\text{h}$	$\text{l/s}$	63	125	250	500	1000	2000	4000	8000	
400 x 200	900	250	45	44	40	40	40	41	41	38	47
	1500	417	47	46	44	44	42	44	44	41	50
	2100	583	47	49	50	49	49	47	47	41	54
	2700	750	50	49	50	51	51	50	50	42	57
400 x 250	1200	333	46	45	41	41	40	42	42	39	48
	1935	538	48	47	45	44	43	45	45	42	51
	2665	740	47	49	50	49	49	47	47	41	54
	3400	944	50	49	50	51	51	50	50	42	57
400 x 300	1500	417	47	46	42	42	41	43	43	40	49
	2400	667	49	48	46	45	44	46	46	43	52
	3300	917	49	51	52	51	51	49	49	43	56
	4200	1167	53	52	53	54	54	53	53	45	60
400 x 400	1800	500	48	48	44	44	43	45	45	42	51
	3000	833	51	50	48	47	46	48	48	45	54
	4200	1167	50	52	53	52	52	50	50	44	57
	5400	1500	55	54	55	56	56	55	55	47	62
500 x 200	1100	306	43	42	38	38	37	39	39	36	45
	1865	518	45	43	42	41	39	42	42	39	48
	2635	732	44	46	47	46	46	44	44	38	51
	3400	944	48	47	48	49	49	48	48	40	55
500 x 250	1500	417	45	44	40	40	39	41	41	38	47
	2400	667	48	47	45	44	42	45	45	42	51
	3300	917	47	49	50	49	49	47	47	41	54
	4200	1167	49	48	49	50	50	49	49	41	56
500 x 300	1800	500	46	45	41	41	40	42	42	39	48
	2800	778	48	47	45	44	42	45	45	42	51
	3800	1056	48	50	51	50	50	48	48	42	55
	4800	1333	51	50	51	52	52	51	51	43	58
500 x 400	2200	611	51	50	46	46	45	47	47	44	53
	3735	1038	54	53	51	50	47	51	51	48	57
	5265	1463	53	55	56	55	55	53	53	47	60
	6800	1889	56	55	56	57	57	56	56	48	63
500 x 500	3000	833	53	52	48	48	48	49	49	46	55
	4800	1333	56	55	53	52	49	53	53	50	59
	6600	1833	55	57	58	57	57	55	55	49	62
	8400	2333	58	57	58	59	59	58	58	50	65
600 x 200	1500	417	43	42	39	39	39	40	40	37	46
	2335	649	47	45	43	42	40	43	43	40	49
	3165	879	46	48	49	48	48	46	46	40	53
	4000	1111	49	48	49	50	50	49	49	41	56
600 x 250	1800	500	45	45	41	41	41	42	42	39	48
	2865	796	48	47	45	44	42	45	45	42	51
	3935	1093	47	49	50	49	49	47	47	41	54
	5000	1389	50	49	50	51	51	50	50	42	57

$\Delta p_{st} = 50 \text{ Pa}$											
Nimimõõt (mm)	$q_v$		$L_w$ (dB/Okt.)								$L_{WA}$ (dB(A))
			$f_m$ (Hz)								
	$\text{m}^3/\text{h}$	$\text{l/s}$	63	125	250	500	1000	2000	4000	8000	
600 x 300	2100	583	48	47	43	43	43	44	44	41	50
	3400	944	49	48	46	45	44	46	46	43	52
	4700	1306	48	50	51	50	50	48	48	42	55
	6000	1667	51	50	51	52	52	51	51	43	58
600 x 400	3000	833	51	50	46	46	46	47	47	44	53
	4665	1296	53	52	50	49	48	50	50	47	56
	6335	1760	53	55	56	55	55	53	53	47	60
	8000	2222	55	54	55	56	56	55	55	47	62
600 x 500	3600	1000	53	52	48	48	48	49	49	46	55
	5735	1593	56	55	53	52	51	53	53	50	59
	7865	2185	55	57	58	57	57	55	55	49	62
	10000	2778	58	57	58	59	59	58	58	50	65
600 x 600	4200	1167	56	55	51	51	51	52	52	49	58
	6800	1889	58	57	55	54	53	55	55	52	61
	9400	2611	57	59	60	59	59	57	57	51	64
	12000	3333	59	58	59	60	60	59	59	51	66

Tabel 6. Mõõra väärtused klapis 100 Pa rõhukao korral

$\Delta p_{st} = 100 \text{ Pa}$											
Nimimõõt (mm)	$q_v$		$L_w$ (dB/Okt.)								$L_{WA}$ (dB(A))
			$f_m$ (Hz)								
	$\text{m}^3/\text{h}$	$\text{l/s}$	63	125	250	500	1000	2000	4000	8000	
200 x 100	250	69	46	45	41	41	41	42	42	39	48
	400	111	49	48	46	45	44	46	46	43	52
	550	153	50	50	51	50	50	48	48	43	55
	700	194	52	51	53	52	52	51	51	45	58
200 x 150	400	111	46	45	42	42	42	43	43	39	49
	600	167	50	49	47	46	45	47	46	43	53
	800	222	51	51	52	51	51	49	49	43	56
	1000	278	52	51	52	53	53	52	52	44	59
200 x 200	500	139	48	47	43	43	43	44	44	41	50
	765	213	50	49	47	46	45	47	47	44	53
	1035	288	49	51	52	51	51	49	49	43	56
	1300	361	52	51	52	53	53	52	52	44	59
300 x 100	400	111	49	48	44	44	44	45	45	42	51
	600	167	51	50	48	47	46	48	48	45	54
	800	222	51	53	54	53	53	51	51	45	58
	1000	278	54	53	54	55	55	54	54	46	61
300 x 150	500	139	47	46	42	42	42	43	43	40	49
	835	232	51	50	48	47	46	48	48	45	54
	1165	324	52	54	55	54	54	52	52	46	59
	1500	417	57	55	56	57	57	56	56	48	63
300 x 200	600	167	50	49	45	45	45	46	46	43	52
	1065	296	53	52	50	49	48	50	50	47	56
	1535	426	53	55	56	55	55	53	53	47	60
	2000	556	57	56	57	58	58	57	57	49	64

$\Delta p_{st} = 100 \text{ Pa}$											
Nimimõõt (mm)	$q_v$		$L_w$ (dB/Okt.)								$L_{WA}$ (dB(A))
			$f_m$ (Hz)								
	$\text{m}^3/\text{h}$	l/s	63	125	250	500	1000	2000	4000	8000	
300 x 250	800	222	51	50	46	46	46	47	47	44	53
	1365	379	55	53	51	50	49	51	51	48	57
	1935	538	53	55	56	55	55	53	53	47	60
	2500	694	56	55	56	57	57	56	56	48	63
300 x 300	1000	278	51	50	46	46	46	47	47	44	53
	4665	1296	54	53	51	50	49	51	51	48	57
	2335	649	54	55	56	55	55	53	53	47	60
	3000	833	56	55	56	57	57	56	56	48	63
400 x 200	900	250	51	50	46	46	46	47	47	44	53
	1500	417	53	52	50	49	48	50	50	47	56
	2100	583	52	54	55	54	54	52	52	46	59
	2700	750	55	54	55	56	56	55	55	47	62
400 x 250	1200	333	52	51	47	47	47	48	48	45	54
	1935	538	54	53	51	50	49	51	51	48	57
	2665	740	53	55	56	55	55	53	53	47	60
	3400	944	55	54	55	56	56	55	55	47	62
400 x 300	1500	417	53	52	48	48	48	49	49	46	55
	2400	667	55	54	52	51	50	52	52	49	58
	3300	917	55	57	58	57	57	55	55	49	62
	4200	1167	59	58	59	60	60	59	59	51	66
400 x 400	1800	500	55	54	50	50	50	51	51	48	57
	3000	833	57	56	54	53	52	54	54	51	60
	4200	1167	56	58	59	58	58	56	56	50	63
	5400	1500	60	59	60	61	61	60	60	52	67
500 x 200	1100	306	49	48	44	44	44	45	45	42	51
	1865	518	51	50	48	47	46	48	48	45	54
	2635	732	50	52	53	52	52	50	50	44	57
	3400	944	53	52	53	54	54	53	53	45	60
500 x 250	1500	417	51	50	46	46	46	47	47	44	53
	2400	667	53	52	50	49	48	50	50	47	56
	3300	917	52	54	55	54	54	52	52	46	59
	4200	1167	54	53	54	55	55	54	54	46	61
500 x 300	1800	500	52	51	47	47	47	48	48	45	54
	2800	778	54	53	51	50	49	51	51	48	57
	3800	1056	53	55	56	55	55	53	53	47	60
	4800	1333	56	55	56	57	57	56	56	48	63
500 x 400	2200	611	56	55	51	51	51	52	52	49	58
	3735	1038	59	58	56	55	54	56	56	53	62
	5265	1463	58	60	61	60	60	58	58	52	65
	6800	1889	61	60	61	62	62	61	61	53	68
500 x 500	3000	833	58	57	53	53	53	54	54	51	60
	4800	1333	61	60	58	57	56	58	58	55	64
	6600	1833	60	62	63	62	62	60	60	54	67
	8400	2333	62	61	62	63	63	62	62	54	69

$\Delta p_{st} = 100 \text{ Pa}$											
Nimimõõt (mm)	$q_v$		$L_w$ (dB/Okt.)								$L_{WA}$ (dB(A))
			$f_m$ (Hz)								
	$\text{m}^3/\text{h}$	l/s	63	125	250	500	1000	2000	4000	8000	
600 x 200	1500	417	50	49	45	45	45	46	46	43	52
	2335	649	53	51	49	48	47	49	49	46	55
	3165	879	51	53	54	53	53	51	51	45	58
	4000	1111	54	53	54	55	55	54	54	46	61
600 x 250	1800	500	52	51	47	47	47	48	48	45	54
	2865	796	54	53	51	50	49	51	51	48	57
	3935	1093	54	55	56	55	55	53	53	47	60
	5000	1389	57	55	56	57	57	56	56	48	63
600 x 300	2100	583	53	52	48	48	48	49	49	46	55
	3400	944	55	54	52	51	50	52	52	49	58
	4700	1306	54	56	57	56	56	54	54	48	61
	6000	1667	56	55	56	57	57	56	56	48	63
600 x 400	3000	833	57	56	52	52	52	53	53	50	59
	4665	1296	59	58	56	55	54	56	56	53	62
	6335	1760	58	60	61	60	60	58	58	52	65
	8000	2222	60	59	60	61	61	60	60	52	67
600 x 500	3600	1000	59	58	54	54	54	55	55	52	61
	5735	1593	61	60	58	57	56	58	58	55	64
	7865	2185	60	62	63	62	62	60	60	54	67
	10000	2778	63	62	63	64	64	63	63	55	70
600 x 600	4200	1167	61	60	56	56	56	57	57	54	63
	6800	1889	63	62	60	59	58	60	60	57	66
	9400	2611	62	64	65	64	64	62	62	56	69
	12000	3333	63	62	63	64	64	63	63	55	70

Tabel 7. Mõõra väärtused klapis 250 Pa rõhukao korral

$\Delta p_{st} = 250 \text{ Pa}$											
Nimimõõt (mm)	$q_v$		$L_w$ (dB/Okt.)								$L_{WA}$ (dB(A))
			$f_m$ (Hz)								
	$\text{m}^3/\text{h}$	l/s	63	125	250	500	1000	2000	4000	8000	
200 x 100	250	69	54	53	49	49	49	50	50	47	56
	400	111	57	56	54	53	52	54	54	51	60
	550	153	56	58	59	58	58	56	56	52	63
	700	194	59	58	59	60	60	59	59	53	66
200 x 150	400	111	55	54	50	50	50	51	52	49	58
	600	167	58	57	55	54	53	55	55	52	61
	800	222	57	58	60	58	59	57	57	51	64
	1000	278	60	59	61	61	61	60	59	53	67
200 x 200	500	139	56	55	51	51	51	52	52	49	58
	765	213	58	57	55	54	53	55	55	52	61
	1035	288	57	59	60	59	59	57	57	51	64
	1300	361	60	59	60	61	61	60	60	52	67
300 x 100	400	111	56	55	51	51	51	52	52	49	58
	600	167	58	57	55	54	53	55	55	52	61
	800	222	57	59	60	59	59	57	57	51	64
	1000	278	60	59	60	61	61	60	60	52	67

$\Delta p_{st} = 250 \text{ Pa}$											
Nimimõõt (mm)	$q_v$		$L_w$ (dB/Okt.)								$L_{WA}$ (dB(A))
			$f_m$ (Hz)								
	$m^3/h$	$l/s$	63	125	250	500	1000	2000	4000	8000	
300 x 150	500	139	56	55	51	51	51	52	52	49	58
	835	232	59	58	56	55	54	56	56	53	62
	1165	324	59	61	62	61	61	59	59	53	66
	1500	417	62	61	62	63	63	62	62	54	69
300 x 200	600	167	59	58	54	54	54	55	55	52	61
	1065	296	61	60	58	57	56	58	58	55	64
	1535	426	61	63	64	63	63	61	61	55	68
	2000	556	64	63	64	65	65	64	64	56	71
300 x 250	800	222	60	59	55	55	55	56	56	53	62
	1365	379	62	61	59	58	57	59	59	56	65
	1935	538	61	63	64	63	63	61	61	55	68
	2500	694	64	63	64	65	65	64	64	56	71
300 x 300	1000	278	61	60	56	56	56	57	57	54	63
	4665	1296	63	62	60	59	58	60	60	57	66
	2335	649	62	64	65	64	64	62	62	56	69
	3000	833	65	64	65	66	66	65	65	57	72
400 x 200	900	250	61	60	56	56	56	57	57	54	63
	1500	417	62	61	59	58	57	59	59	56	65
	2100	583	61	63	64	63	63	61	61	55	68
	2700	750	63	62	63	64	64	63	63	55	70
400 x 250	1200	333	61	60	56	56	56	57	57	54	63
	1935	538	63	62	60	59	58	60	60	57	66
	2665	740	61	63	64	63	63	61	61	55	68
	3400	944	63	62	63	64	64	63	63	55	70
400 x 300	1500	417	62	61	57	57	57	58	58	55	64
	2400	667	64	63	61	60	59	61	61	58	67
	3300	917	64	65	66	65	65	63	63	57	70
	4200	1167	66	65	66	67	67	66	66	58	73
400 x 400	1800	500	64	63	59	59	59	60	60	57	66
	3000	833	66	65	63	62	61	63	63	60	69
	4200	1167	64	66	67	66	66	64	64	58	71
	5400	1500	67	66	67	68	68	67	67	59	74
500 x 200	1100	306	59	58	54	54	54	55	55	52	61
	1865	518	61	60	58	57	56	58	58	55	64
	2635	732	59	61	62	61	61	59	59	53	66
	3400	944	61	60	61	62	62	61	61	53	68
500 x 250	1500	417	61	60	56	56	56	57	57	54	63
	2400	667	62	61	59	58	57	59	59	56	65
	3300	917	60	62	63	62	62	60	60	54	67
	4200	1167	62	61	62	63	63	62	62	54	69
500 x 300	1800	500	62	61	57	57	57	58	58	55	64
	2800	778	63	62	60	59	58	60	60	57	66
	3800	1056	61	63	64	63	63	61	61	55	68
	4800	1333	63	62	63	64	64	63	63	55	70



$\Delta p_{st} = 250 \text{ Pa}$											
Nimimõõt (mm)	$q_v$		$L_w$ (dB/Okt.)								$L_{WA}$ (dB(A))
			$f_m$ (Hz)								
	$m^3/h$	$l/s$	63	125	250	500	1000	2000	4000	8000	
500 x 400	2200	611	65	64	60	60	60	61	61	58	67
	3735	1038	67	66	64	63	62	64	64	61	70
	5265	1463	66	68	69	68	68	66	66	60	73
	6800	1889	69	68	69	70	70	69	69	61	76
500 x 500	3000	833	67	66	62	62	62	63	63	60	69
	4800	1333	69	68	66	65	64	66	66	63	72
	6600	1833	67	69	70	69	69	67	67	61	74
	8400	2333	69	68	69	70	70	69	69	61	76
600 x 200	1500	417	59	58	54	54	54	55	55	52	61
	2335	649	61	60	58	57	56	58	58	55	64
	3165	879	59	61	62	61	61	59	59	53	66
	4000	1111	62	61	62	63	63	62	62	54	69
600 x 250	1800	500	60	59	55	55	55	56	56	53	62
	2865	796	63	61	59	58	57	59	59	56	65
	3935	1093	61	63	64	63	63	61	61	55	68
	5000	1389	64	63	64	65	65	64	64	56	71
600 x 300	2100	583	62	61	57	57	57	58	58	55	64
	3400	944	63	62	60	59	58	60	60	57	66
	4700	1306	61	63	64	63	63	61	61	55	68
	6000	1667	63	62	63	64	64	63	63	55	70
600 x 400	3000	833	65	64	60	60	60	61	61	58	67
	4665	1296	67	66	64	63	62	64	64	61	70
	6335	1760	66	68	69	68	68	66	66	60	73
	8000	2222	68	67	68	69	69	68	68	60	75
600 x 500	3600	1000	67	66	62	62	62	63	63	60	69
	5735	1593	69	68	66	65	64	66	66	63	72
	7865	2185	68	70	71	70	70	68	68	62	75
	10000	2778	71	70	71	72	72	71	71	63	78
600 x 600	4200	1167	70	69	65	65	65	66	66	63	72
	6800	1889	71	70	68	67	66	68	68	65	74
	9400	2611	69	71	72	71	71	69	69	63	76
	12000	3333	70	69	70	71	71	70	70	62	77

Tabel 8. Mõõra väärtused klapis 500 Pa rõhukao korral

$\Delta p_{st} = 500 \text{ Pa}$											
Nimimõõt (mm)	$q_v$		$L_w$ (dB/Okt.)								$L_{WA}$ (dB(A))
			$f_m$ (Hz)								
	$m^3/h$	$l/s$	63	125	250	500	1000	2000	4000	8000	
200 x 100	250	69	60	59	55	55	55	56	56	53	62
	400	111	63	62	60	59	58	60	60	57	66
	550	153	64	63	65	64	64	62	62	59	69
	700	194	66	65	66	67	67	66	66	65	73
200 x 150	400	111	62	61	57	57	56	58	57	54	64
	600	167	64	63	61	60	59	60	60	57	67
	800	222	63	65	66	65	65	63	63	57	70
	1000	278	66	65	67	67	67	66	66	58	73

$\Delta p_{st} = 500 \text{ Pa}$											
Nimimõõt (mm)	$q_v$		$L_w$ (dB/Okt.)								$L_{WA}$ (dB(A))
			$f_m$ (Hz)								
	$m^3/h$	$l/s$	63	125	250	500	1000	2000	4000	8000	
200 x 200	500	139	62	61	57	57	57	58	58	55	64
	765	213	65	64	62	61	60	62	62	59	68
	1035	288	64	66	67	66	66	64	64	58	71
	1300	361	67	66	67	68	68	67	67	59	74
300 x 100	400	111	62	61	57	57	57	58	58	55	64
	600	167	64	63	61	60	59	61	61	58	67
	800	222	63	65	66	65	65	63	63	57	70
	1000	278	66	65	66	67	67	66	66	58	73
300 x 150	500	139	62	61	57	57	57	58	58	55	64
	835	232	65	64	62	61	60	62	62	59	68
	1165	324	65	67	68	67	67	65	65	59	72
	1500	417	68	67	68	69	69	68	68	60	75
300 x 200	600	167	65	64	60	60	60	61	61	58	67
	1065	296	68	67	65	64	63	65	65	62	71
	1535	426	67	69	70	69	69	67	67	61	74
	2000	556	70	69	70	71	71	70	70	62	77
300 x 250	800	222	67	66	62	62	62	63	63	60	69
	1365	379	69	68	66	65	64	66	66	63	72
	1935	538	68	70	71	70	70	68	68	62	75
	2500	694	71	70	71	72	72	71	71	63	78
300 x 300	1000	278	68	67	63	63	63	64	64	61	70
	4665	1296	70	69	67	66	65	67	67	64	73
	2335	649	69	71	72	71	71	69	69	63	76
	3000	833	72	71	72	73	73	72	72	64	79
400 x 200	900	250	68	67	63	63	63	64	64	61	70
	1500	417	70	69	67	66	65	67	67	64	73
	2100	583	68	70	71	70	70	68	68	62	75
	2700	750	70	69	70	71	71	70	70	62	77
400 x 250	1200	333	67	66	62	62	65	63	63	60	70
	1935	538	70	69	67	66	66	67	67	64	73
	2665	740	68	70	71	70	66	68	68	62	75
	3400	944	70	69	70	71	71	70	70	62	77
400 x 300	1500	417	68	67	63	63	66	64	64	61	71
	2400	667	71	70	68	67	67	68	68	65	74
	3300	917	69	71	72	71	67	69	69	63	76
	4200	1167	71	70	71	72	72	71	71	63	78
400 x 400	1800	500	71	69	65	65	68	66	66	63	73
	3000	833	73	72	70	69	69	70	70	67	76
	4200	1167	71	73	74	73	69	71	71	65	78
	5400	1500	73	72	73	74	74	73	73	65	80
500 x 200	1100	306	66	65	61	61	64	62	62	59	69
	1865	518	67	66	64	63	66	64	64	61	71
	2635	732	66	68	69	68	65	66	66	60	73
	3400	944	69	68	69	70	66	69	69	61	75

$\Delta p_{st} = 500 \text{ Pa}$											
Nimimõõt (mm)	$q_v$		$L_w$ (dB/Okt.)								$L_{WA}$ (dB(A))
			$f_m$ (Hz)								
	$\text{m}^3/\text{h}$	$\text{l/s}$	63	125	250	500	1000	2000	4000	8000	
500 x 250	1500	417	67	66	62	62	65	63	63	60	70
	2400	667	68	67	65	64	67	65	65	62	72
	3300	917	67	69	70	69	66	67	67	61	74
	4200	1167	70	69	70	71	67	70	70	62	76
500 x 300	1800	500	68	67	63	63	66	64	64	61	71
	2800	778	69	68	66	65	68	66	66	63	73
	3800	1056	68	70	71	70	67	68	68	62	75
	4800	1333	71	70	71	72	68	71	71	63	77
500 x 400	2200	611	70	69	65	65	68	66	66	63	73
	3735	1038	72	71	69	68	71	69	69	66	76
	5265	1463	72	74	75	74	74	72	72	66	79
	6800	1889	76	75	76	77	74	76	76	68	82
500 x 500	3000	833	74	73	69	69	68	70	70	67	76
	4800	1333	75	74	72	71	74	72	72	69	79
	6600	1833	74	76	77	76	76	74	74	68	81
	8400	2333	77	76	77	78	75	77	77	69	83
600 x 200	1500	417	66	65	61	61	60	62	62	59	68
	2335	649	67	66	64	63	66	64	64	61	71
	3165	879	66	68	69	68	68	66	66	60	73
	4000	1111	70	69	70	71	68	70	70	62	76
600 x 250	1800	500	67	66	62	62	61	63	63	60	69
	2865	796	68	67	65	64	67	65	65	62	72
	3935	1093	68	70	71	70	70	68	68	62	75
	5000	1389	71	70	71	72	72	71	71	63	78
600 x 300	2100	583	68	67	63	63	63	64	64	61	70
	3400	944	69	68	66	65	64	66	66	63	72
	4700	1306	67	69	70	69	69	67	67	61	74
	6000	1667	69	68	69	70	70	69	69	61	76
600 x 400	3000	833	72	71	67	67	67	68	68	65	74
	4665	1296	74	73	71	70	69	71	71	68	77
	6335	1760	73	75	76	75	75	73	73	67	80
	8000	2222	75	74	75	76	76	75	75	67	82
600 x 500	3600	1000	74	73	69	69	69	70	70	67	76
	5735	1593	75	74	72	71	70	72	72	69	78
	7865	2185	74	76	77	76	76	74	74	68	81
	10000	2778	77	76	77	78	78	77	77	69	84
600 x 600	4200	1167	76	75	71	71	71	72	72	69	78
	6800	1889	77	76	74	73	72	74	74	71	80
	9400	2611	75	77	78	77	77	75	75	69	82
	12000	3333	76	75	76	77	77	76	76	68	83

Müraväärtuste diagrammid  $L_{WA}$  [dB(A)]

Diagramm nr. 1 – 200 × 100



Diagramm nr. 2 – 200 × 150



Diagramm nr. 3 – 200 × 100

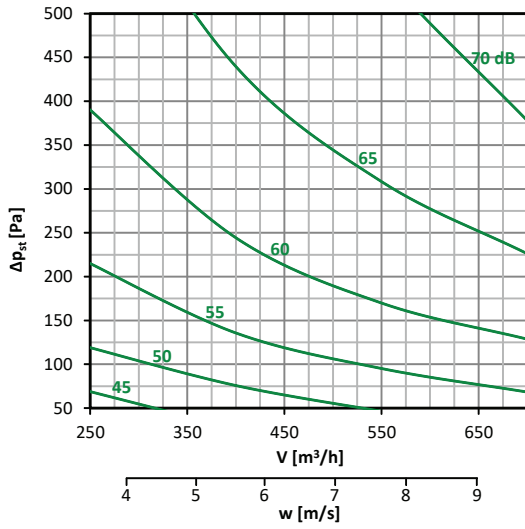

Diagramm nr. 4 – 300 × 100

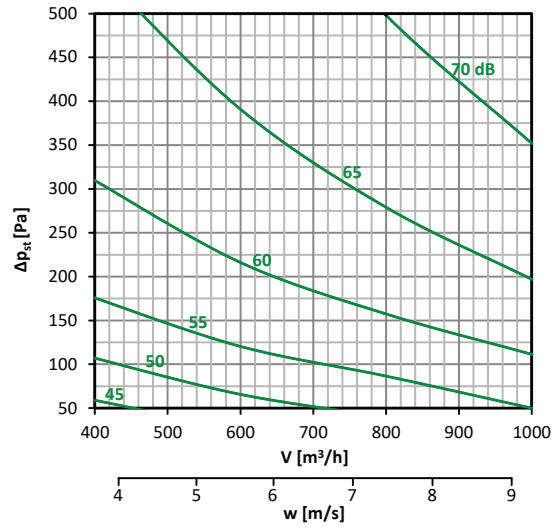

Diagramm nr. 5 – 300 × 150

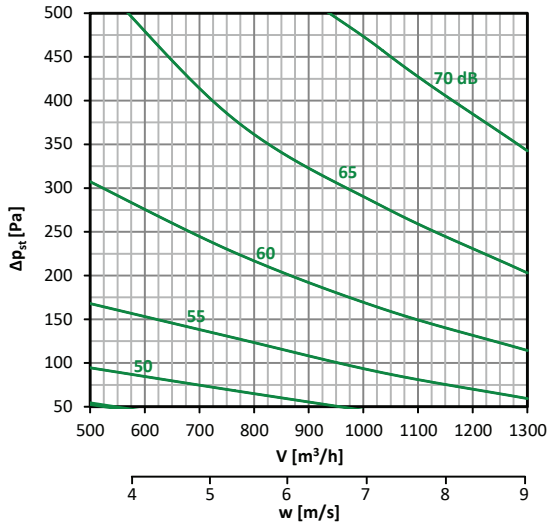

Diagramm nr. 6 – 300 × 200

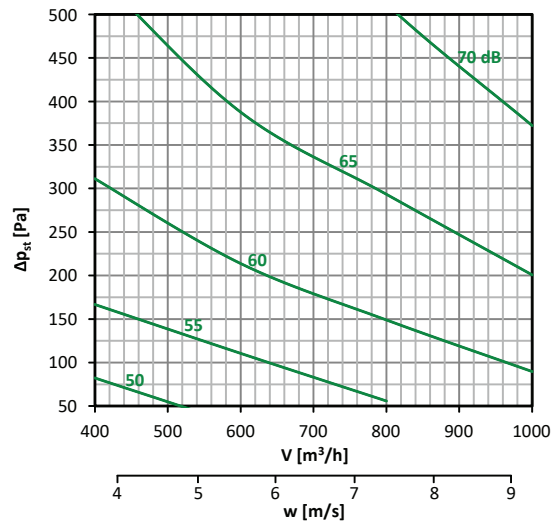

Diagramm nr. 7 – 300 × 250

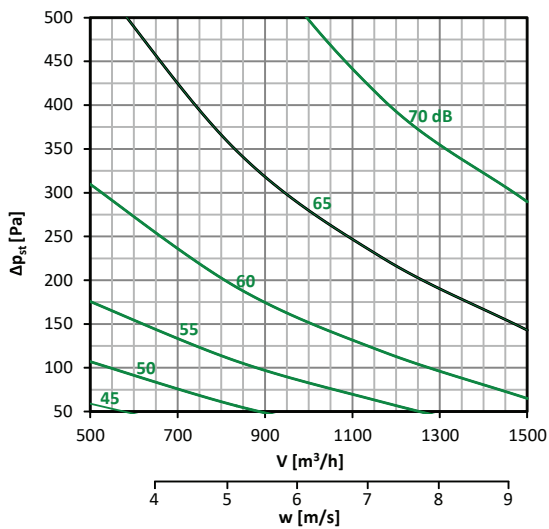

Diagramm nr. 8 – 300 × 300

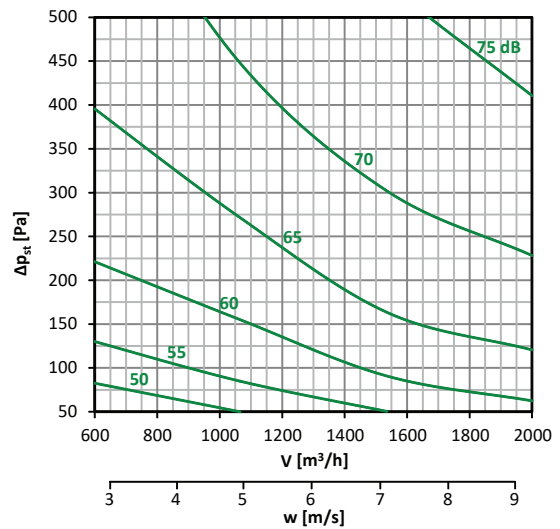

Diagramm nr. 9 – 400 × 200

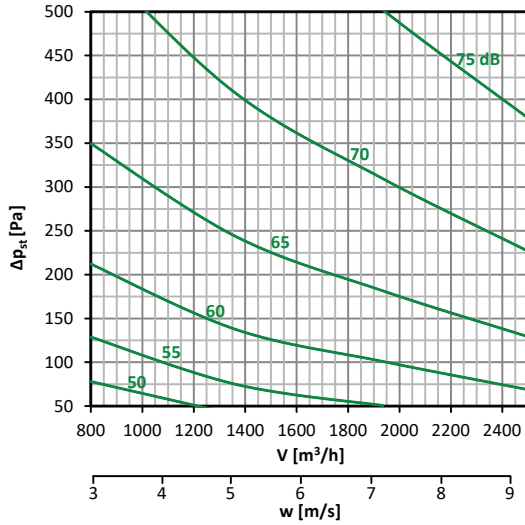

Diagramm nr. 10 – 400 × 250

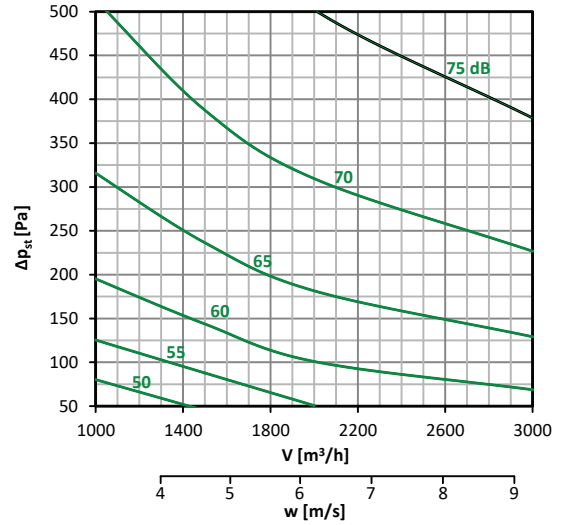

Diagramm nr. 11 – 400 × 300

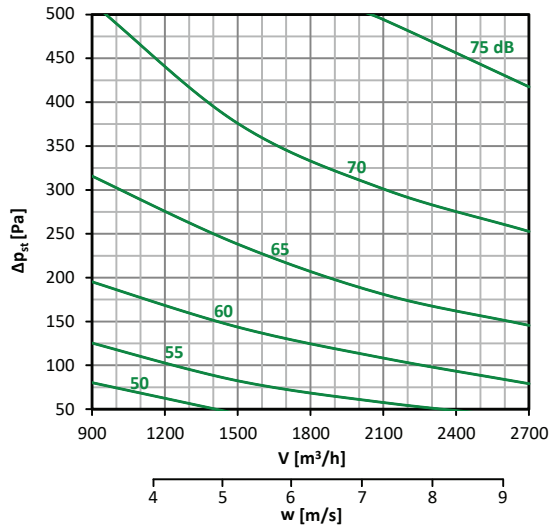

Diagramm nr. 12 – 400 × 400

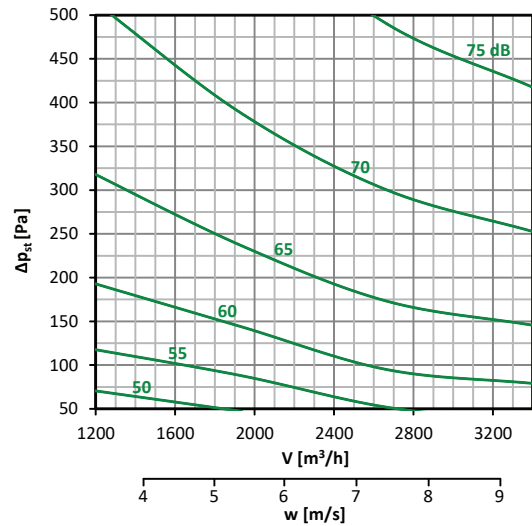

Diagramm nr. 13 – 500 × 200

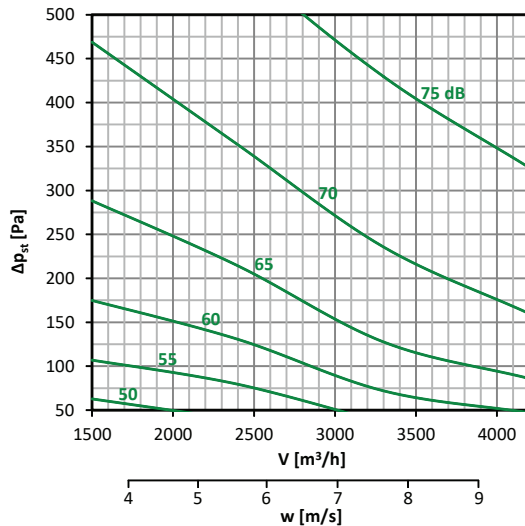

Diagramm nr. 14 – 500 × 250

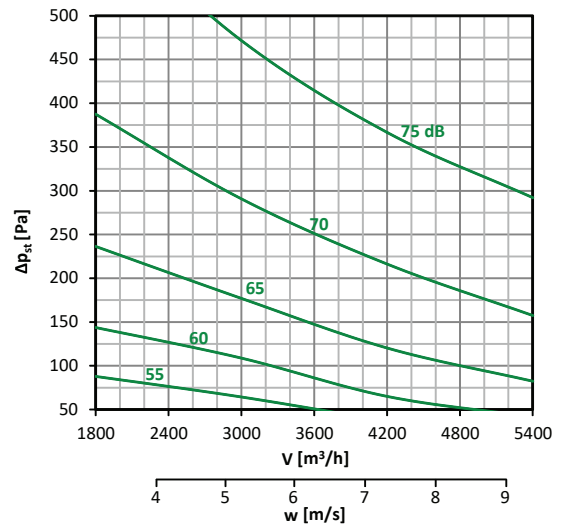

Diagramm nr. 15 – 500 × 300

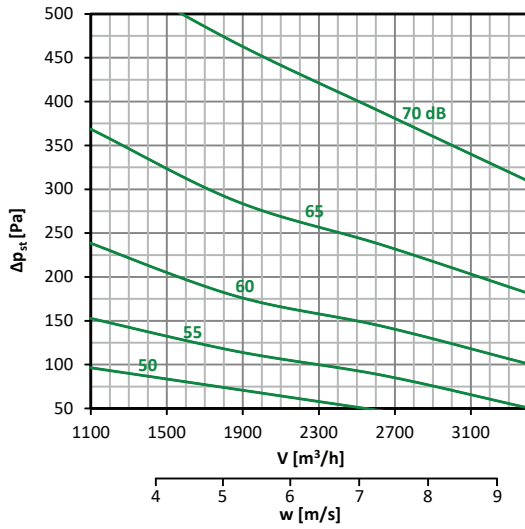

Diagramm nr. 16 – 500 × 400

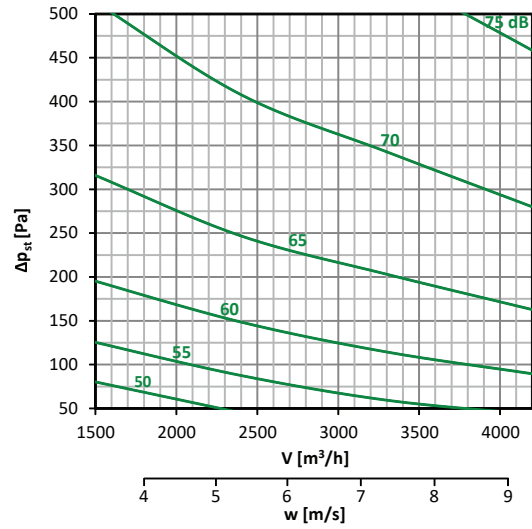

Diagramm nr. 17 – 500 × 500

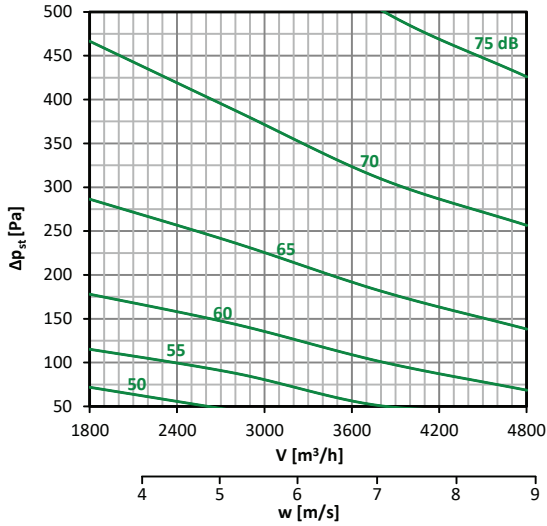

Diagramm nr. 18 – 600 × 200

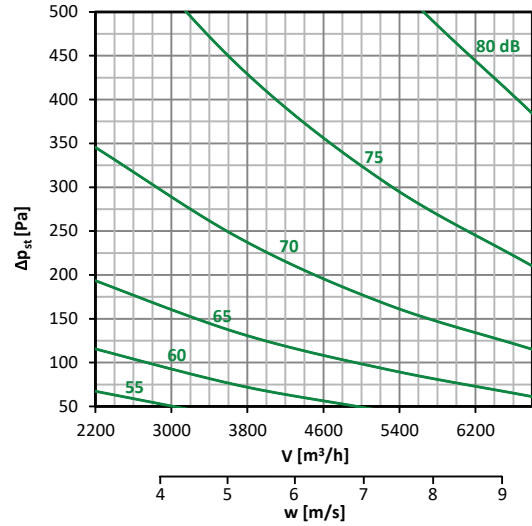

Diagramm nr. 19 – 600 × 250

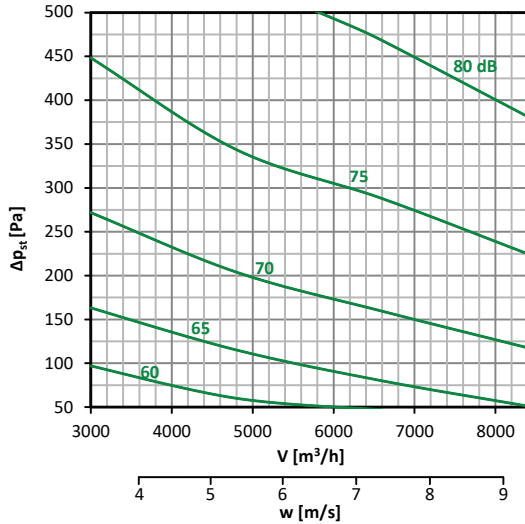

Diagramm nr. 20 – 600 × 300

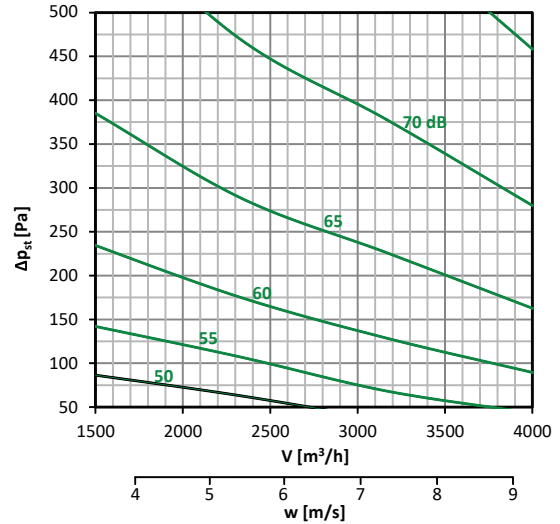

Diagramm nr. 21 – 600 × 400

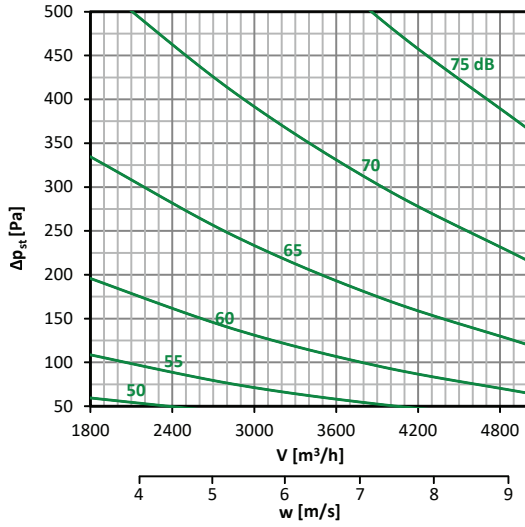

Diagramm nr. 22 – 600 × 500

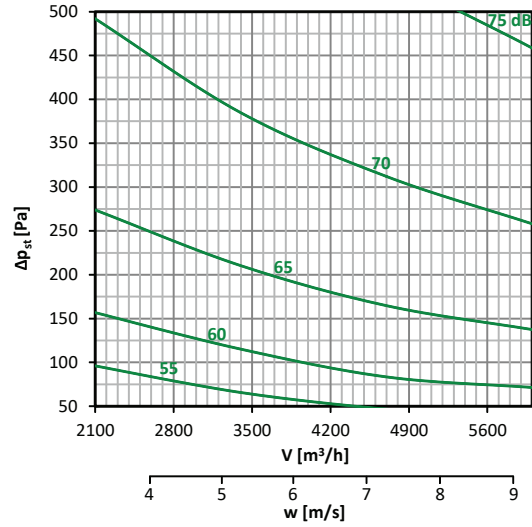

Diagramm nr. 23 – 600 × 600

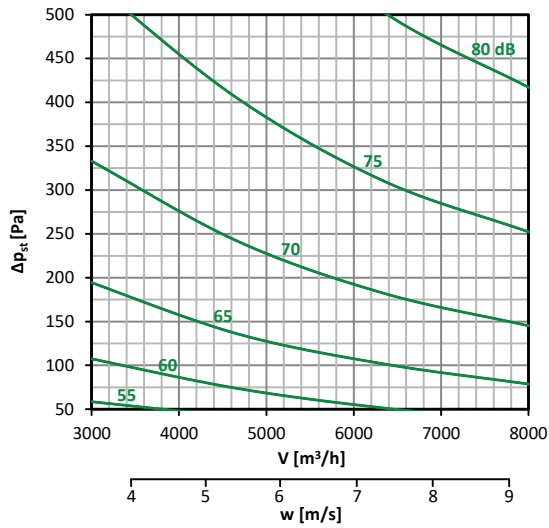

## 6.1 Isoleerimata klapi müra

Klapi poolt tekitatud kiirguva müra väärtused on ära toodud tabelis..

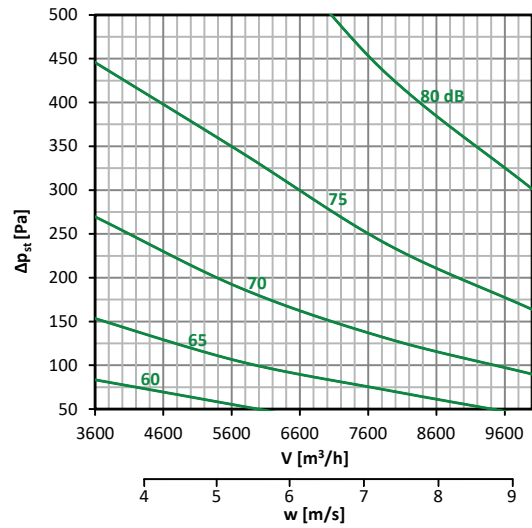
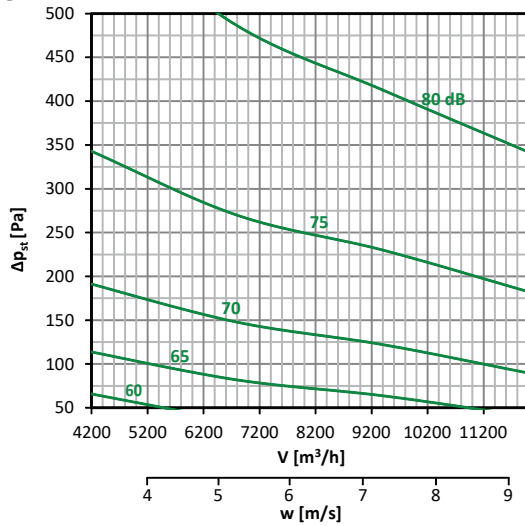
$q_v$  ( $m^3/h$ ;  $l/s$ ) – õhuhulk

LWA [dB(A)] – A filtriga korrigeeritud helivõimsuse tase

$\Delta p_{st}$  (Pa) – rõhuvahe

Nimimõõt (mm)	$q_v$		L <sub>WA</sub> [dB(A)]			
	$m^3/h$	$l/s$	$\Delta p_{st} = 50$ Pa	$\Delta p_{st} = 100$ Pa	$\Delta p_{st} = 250$ Pa	$\Delta p_{st} = 500$ Pa
200 × 100	250	69	33	39	48	55
	400	111	38	43	51	57
	550	153	42	46	53	59
	700	194	45	49	55	61
200 × 150	400	111	34	39	46	52
	600	167	38	42	49	55
	800	222	41	45	52	58
	1000	278	43	48	55	61
200 × 200	500	139	35	40	47	53
	765	213	40	44	51	56
	1035	288	43	47	54	59
	1300	361	45	49	56	62
300 × 100	400	111	36	40	46	52
	600	167	40	44	50	56
	800	222	43	47	53	59
	1000	278	45	49	55	61
300 × 150	500	139	35	39	46	52
	835	232	40	44	51	57
	1165	324	44	48	54	60
	1500	417	47	51	57	63
300 × 200	600	167	35	40	48	54
	1065	296	39	44	52	58
	1535	426	43	48	55	61
	2000	556	46	51	58	64
300 × 250	800	222	36	41	49	56
	1365	379	40	45	53	60
	1935	538	44	49	56	63
	2500	694	47	52	59	66
300 × 300	1000	278	36	41	49	57
	4665	1296	40	45	53	61
	2335	649	44	49	57	64
	3000	833	48	53	60	67
400 × 200	900	250	35	40	48	55
	1500	417	40	45	52	59
	2100	583	43	48	55	61
	2700	750	45	50	57	63
400 × 250	1200	333	38	43	50	56
	1935	538	42	47	54	60
	2665	740	45	50	57	63
	3400	944	47	52	59	65
400 × 300	1500	417	39	44	52	58
	2400	667	43	48	56	62
	3300	917	46	51	59	65
	4200	1167	48	53	61	67



Nimimõõt (mm)	$q_v$		$L_{WA}$ [dB(A)]			
	$m^3/h$	l/s	$\Delta p_{st} = 50 \text{ Pa}$	$\Delta p_{st} = 100 \text{ Pa}$	$\Delta p_{st} = 250 \text{ Pa}$	$\Delta p_{st} = 500 \text{ Pa}$
400 x 400	1800	500	43	48	56	62
	3000	833	46	51	59	65
	4200	1167	48	53	61	67
	5400	1500	50	55	63	69
500 x 200	1100	306	35	40	48	55
	1865	518	40	45	52	58
	2635	732	43	48	55	61
	3400	944	47	51	58	63
500 x 250	1500	417	36	41	49	56
	2400	667	40	45	53	60
	3300	917	43	48	56	63
	4200	1167	46	52	59	66
500 x 300	1800	500	38	43	51	57
	2800	778	42	47	55	61
	3800	1056	44	49	58	64
	4800	1333	47	52	60	66
500 x 400	2200	611	42	46	54	60
	3735	1038	46	50	57	63
	5265	1463	49	53	60	66
	6800	1889	52	56	63	69
500 x 500	3000	833	45	50	57	63
	4800	1333	48	53	60	66
	6600	1833	51	56	63	68
	8400	2333	55	59	65	70
600 x 200	1500	417	35	40	48	55
	2335	649	39	44	52	59
	3165	879	42	47	55	62
	4000	1111	45	50	58	65
600 x 250	1800	500	36	42	50	56
	2865	796	40	45	53	60
	3935	1093	43	48	56	63
	5000	1389	46	51	59	66
600 x 300	2100	583	38	43	51	57
	3400	944	42	47	54	60
	4700	1306	45	50	57	63
	6000	1667	48	53	60	66
600 x 400	3000	833	40	45	53	60
	4665	1296	44	49	56	63
	6335	1760	47	52	59	65
	8000	2222	51	55	61	67
600 x 500	3600	1000	43	48	56	62
	5735	1593	46	51	59	65
	7865	2185	48	53	61	67
	10000	2778	51	56	63	69
600 x 600	4200	1167	45	50	57	63
	6800	1889	48	53	60	66
	9400	2611	51	55	62	68
	12000	3333	53	57	64	70

Isoleerimata klapi müra väärtuste diagramm  $L_{WA}$  [dB(A)]

Diagramm nr. 24 – 200 × 100



Diagramm nr. 25 – 200 × 150



Diagramm nr. 26 – 200 × 200

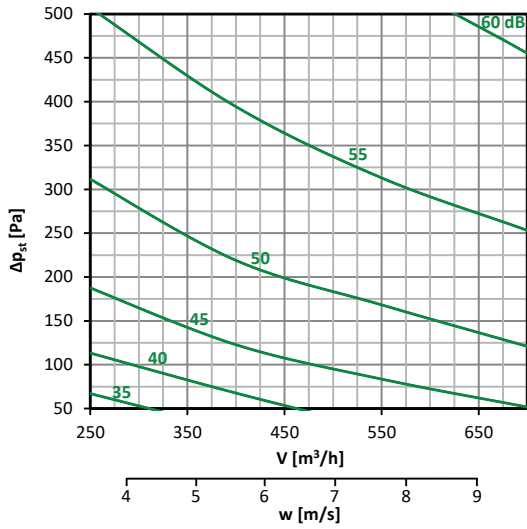

Diagramm nr. 27 – 300 × 100

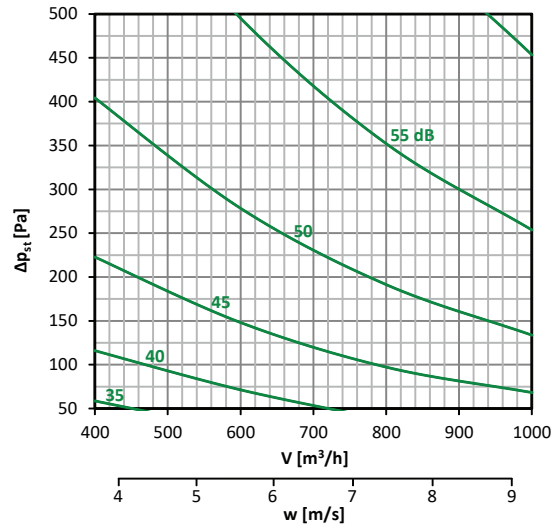

Diagramm nr. 28 – 300 × 150

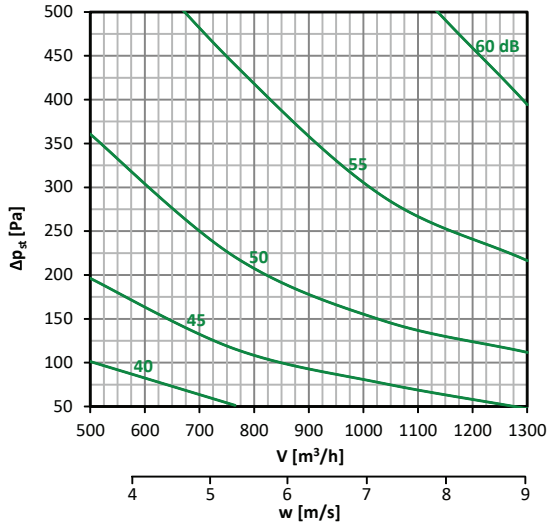

Diagramm nr. 29 – 300 × 200

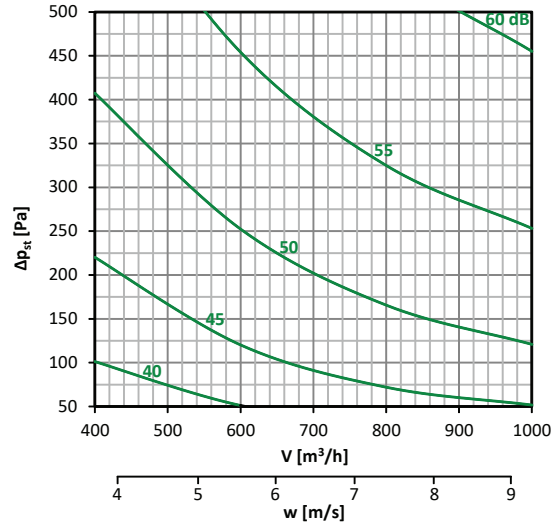

Diagramm nr. 30 – 300 × 250

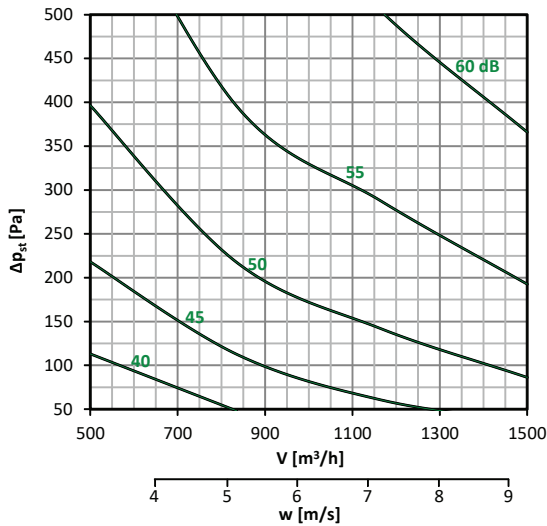

Diagramm nr. 31 – 300 × 300

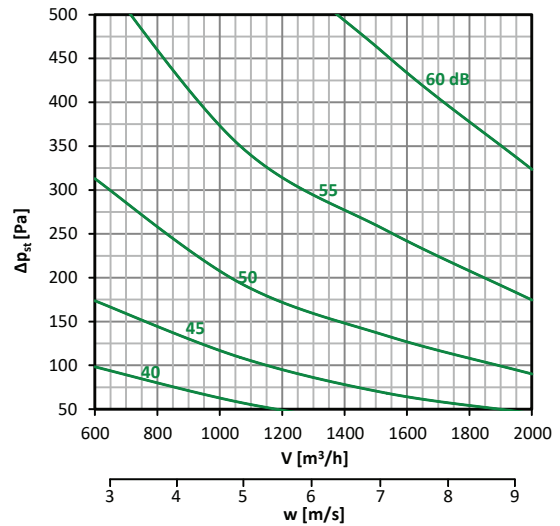

Diagramm nr. 32 – 400 × 200

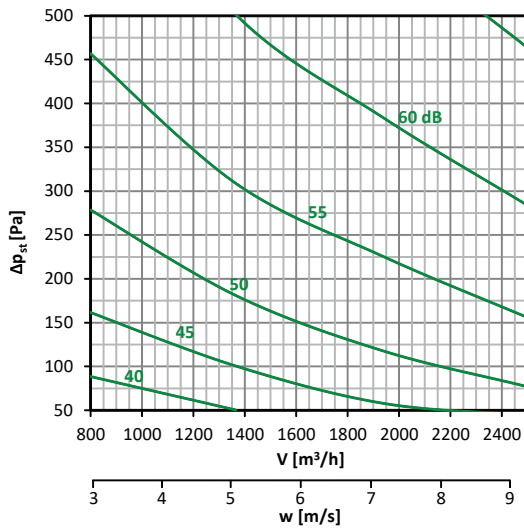

Diagramm nr. 33 – 400 × 250

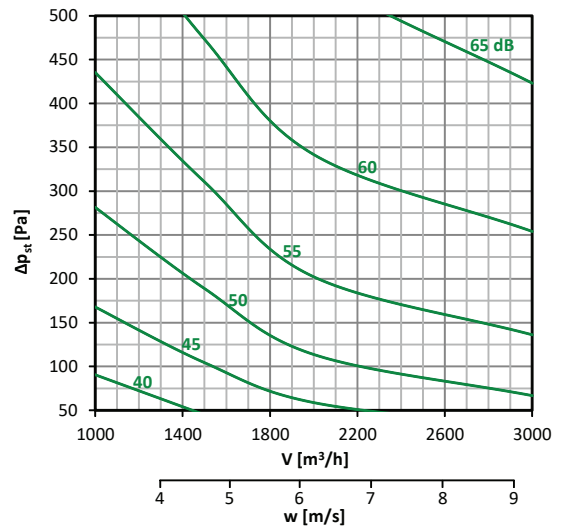

Diagramm nr. 34 – 400 × 300

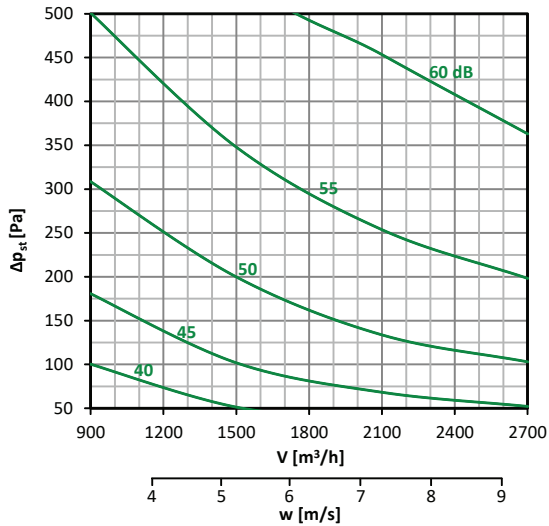

Diagramm nr. 35 – 400 × 400

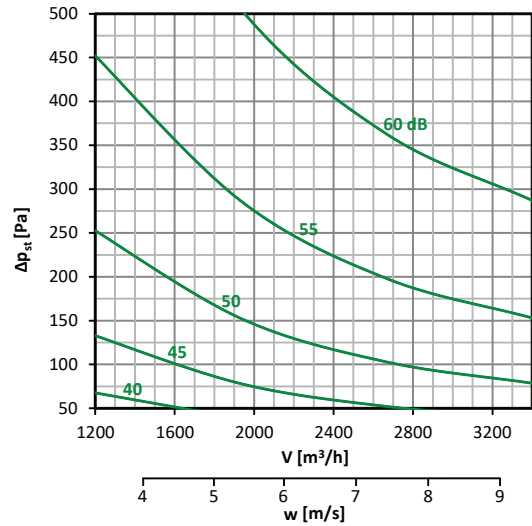

Diagramm nr. 36 – 500 × 200

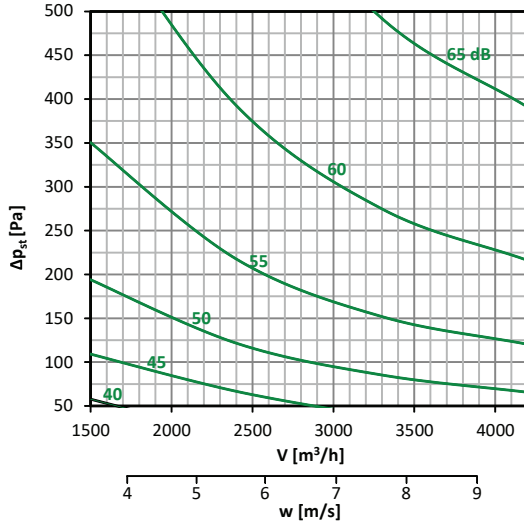

Diagramm nr. 37 – 500 × 250

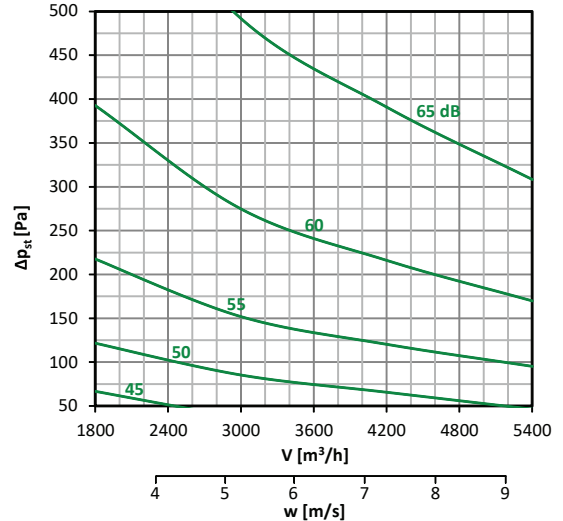

Diagramm nr. 38 – 500 × 300

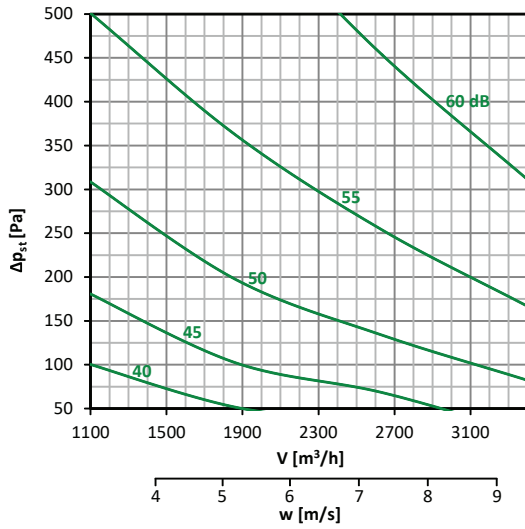

Diagramm nr. 39 – 500 × 400

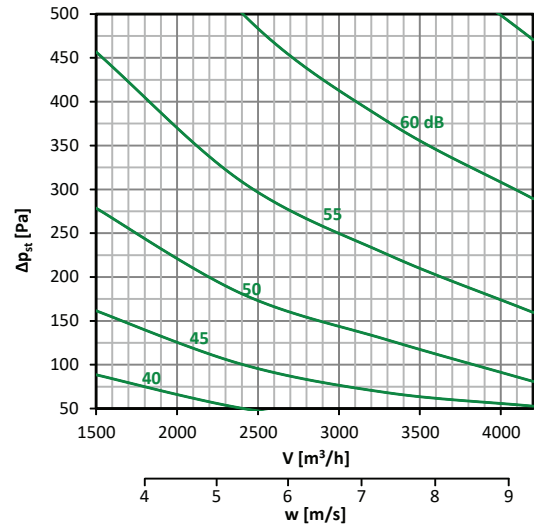

Diagramm nr. 40 – 500 × 400

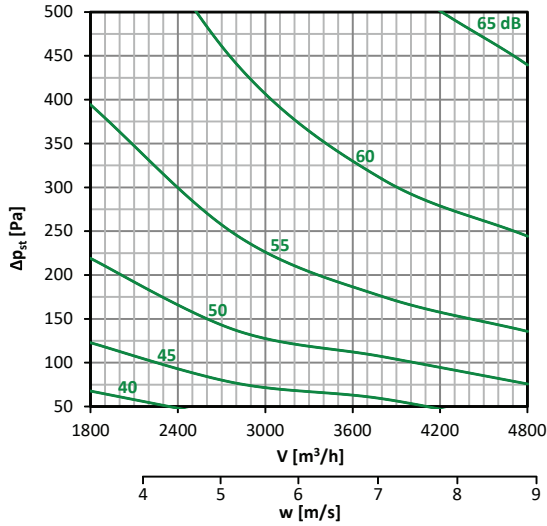

Diagramm nr. 41 – 600 × 200

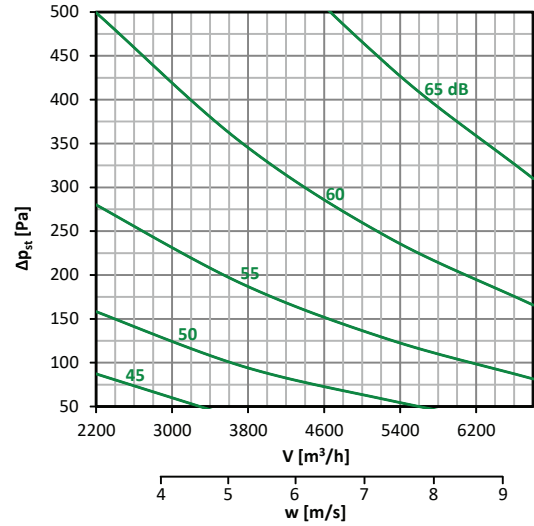

Diagramm nr. 42 – 600 × 250

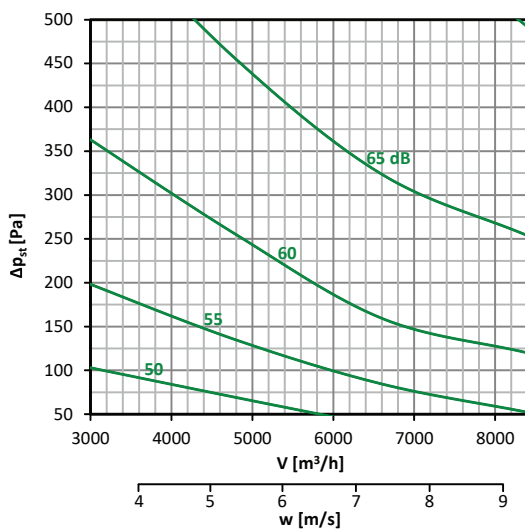

Diagramm nr. 43 – 600 × 300

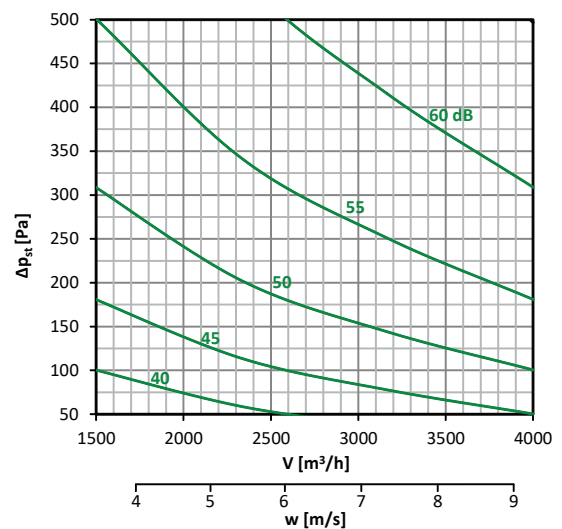

Diagramm nr. 44 – 600 × 400

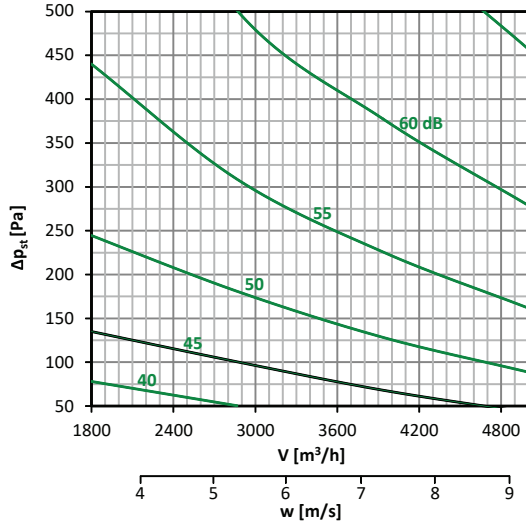

Diagramm nr. 45 – 600 × 500

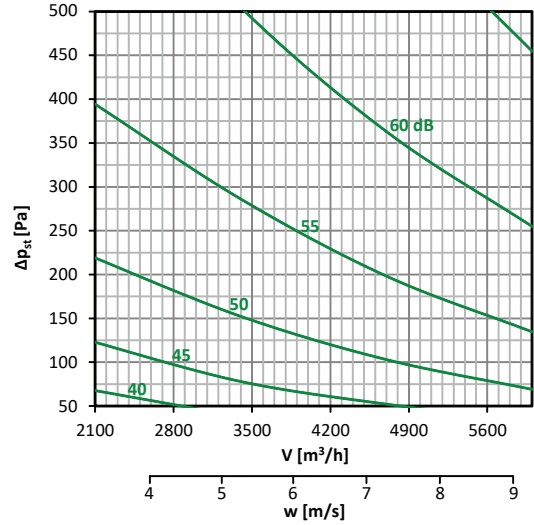

Diagramm nr. 46 – 600 × 600

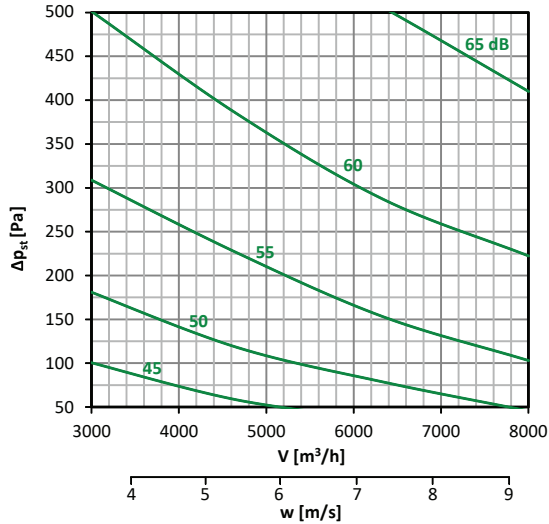

## 6.2 Isoleeritud klapi müra

Klapi poolt tekitatud kiirguva müra väärtused on ära toodud tabelis.

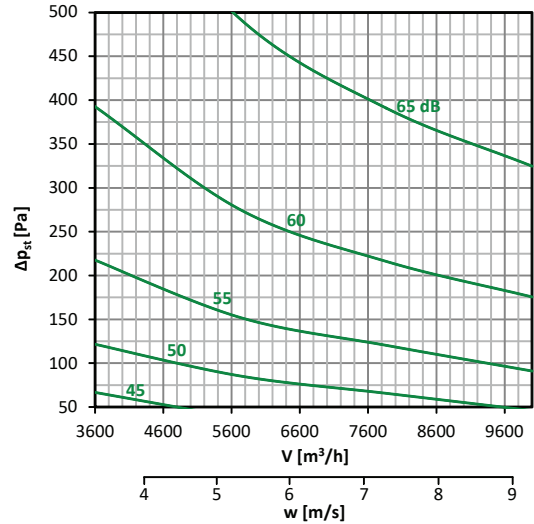
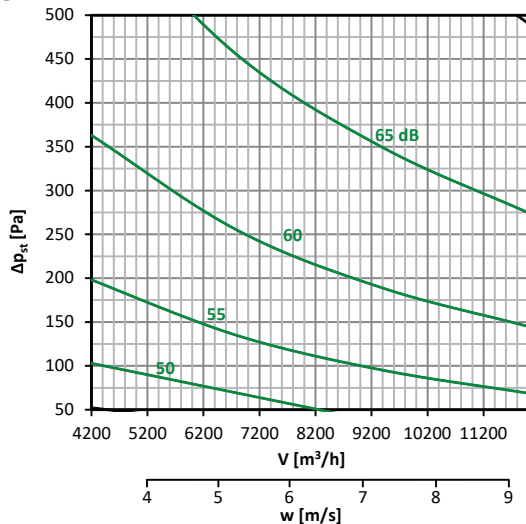
$q_v$  (m<sup>3</sup>/h; l/s) – õhuhulk

$L_{WA}$  [dB(A)] – A filtriga korrigeeritud helivõimsuse tase

$\Delta p_{st}$  (Pa) – rõhuvahe

Nimimõõt (mm)	$q_v$		$L_{WA}$ [dB(A)]			
	m <sup>3</sup> /h	l/s	$\Delta p_{st} = 50$ Pa	$\Delta p_{st} = 100$ Pa	$\Delta p_{st} = 250$ Pa	$\Delta p_{st} = 500$ Pa
200 x 100	250	69	24	28	33	38
	400	111	30	34	39	44
	550	153	34	38	43	48
	700	194	37	41	46	52
200 x 150	400	111	26	29	34	38
	600	167	32	35	40	44
	800	222	35	39	44	49
	1000	278	39	43	48	53
200 x 200	500	139	28	31	35	39
	765	213	33	36	41	45
	1035	288	37	40	46	50
	1300	361	40	44	50	54
300 x 100	400	111	27	31	36	41
	600	167	33	36	41	45
	800	222	36	39	44	48
	1000	278	39	42	47	51
300 x 150	500	139	26	30	36	41
	835	232	33	37	42	47
	1165	324	38	41	46	50
	1500	417	42	45	50	54
300 x 200	600	167	26	30	38	44
	1065	296	30	35	43	49
	1535	426	34	39	47	53
	2000	556	36	41	49	56
300 x 250	800	222	26	31	38	45
	1365	379	31	35	43	50
	1935	538	35	40	47	54
	2500	694	38	43	50	57
300 x 300	1000	278	26	31	39	46
	4665	1296	31	36	44	51
	2335	649	35	40	48	54
	3000	833	38	43	51	57
400 x 200	900	250	24	29	37	44
	1500	417	29	34	42	48
	2100	583	32	37	45	51
	2700	750	35	40	48	54
400 x 250	1200	333	27	32	40	46
	1935	538	30	36	44	50
	2665	740	34	39	47	53
	3400	944	37	42	50	56
400 x 300	1500	417	29	34	42	48
	2400	667	34	39	46	52
	3300	917	37	42	49	55
	4200	1167	40	45	42	57

Nimimõõt (mm)	$q_v$		$L_{WA}$ [dB(A)]			
	$m^3/h$	l/s	$\Delta p_{st} = 50 \text{ Pa}$	$\Delta p_{st} = 100 \text{ Pa}$	$\Delta p_{st} = 250 \text{ Pa}$	$\Delta p_{st} = 500 \text{ Pa}$
400 x 400	1800	500	30	36	43	49
	3000	833	35	40	47	53
	4200	1167	39	44	51	57
	5400	1500	42	47	54	60
500 x 200	1100	306	24	28	36	43
	1865	518	29	33	40	47
	2635	732	33	37	44	50
	3400	944	37	41	48	53
500 x 250	1500	417	26	31	38	44
	2400	667	30	35	42	48
	3300	917	33	38	45	51
	4200	1167	37	41	48	54
500 x 300	1800	500	27	32	39	45
	2800	778	31	36	43	49
	3800	1056	34	39	46	52
	4800	1333	37	42	49	55
500 x 400	2200	611	30	34	41	48
	3735	1038	35	39	46	53
	5265	1463	38	43	50	57
	6800	1889	42	47	54	61
500 x 500	3000	833	35	40	47	53
	4800	1333	38	43	50	56
	6600	1833	41	46	53	59
	8400	2333	44	49	56	62
600 x 200	1500	417	25	29	37	43
	2335	649	29	33	41	47
	3165	879	32	37	45	51
	4000	1111	36	41	48	54
600 x 250	1800	500	26	31	38	44
	2865	796	30	35	42	48
	3935	1093	33	38	46	51
	5000	1389	37	42	49	54
600 x 300	2100	583	27	32	40	46
	3400	944	31	36	44	50
	4700	1306	34	39	47	53
	6000	1667	36	42	50	56
600 x 400	3000	833	30	35	42	48
	4665	1296	34	39	46	52
	6335	1760	37	42	49	55
	8000	2222	41	46	52	58
600 x 500	3600	1000	32	37	44	50
	5735	1593	36	41	48	54
	7865	2185	40	45	52	58
	10000	2778	44	49	56	62
600 x 600	4200	1167	35	40	48	54
	6800	1889	39	44	51	57
	9400	2611	42	47	54	60
	12000	3333	46	50	57	62

Isoleerimata klapi müra väärtuste diagramm  $L_{WA}$  [dB(A)]

Diagramm nr. 47 – 200 × 100



Diagramm nr. 48 – 200 × 150



Diagramm nr. 49 – 200 × 200

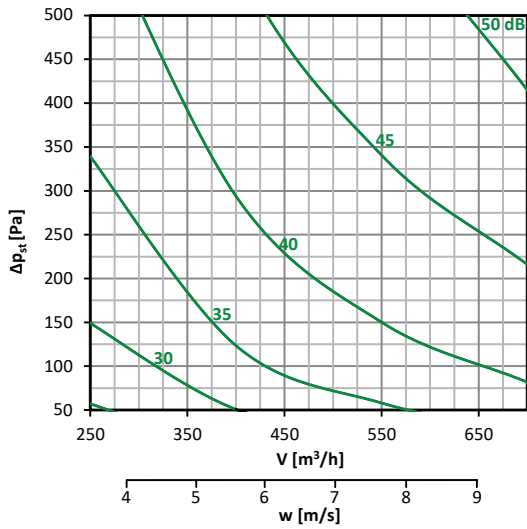

Diagramm nr. 50 – 3600 × 100

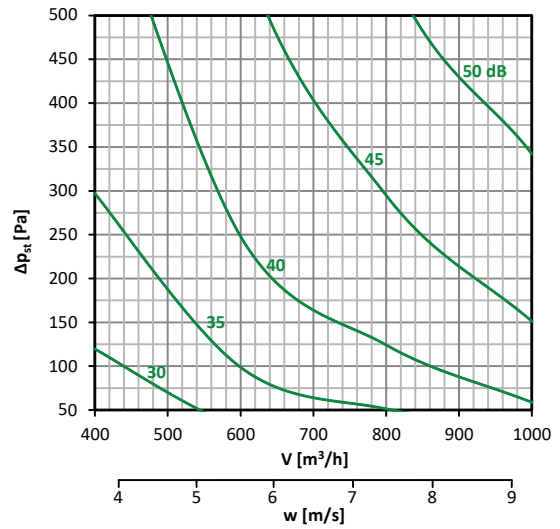

Diagramm nr. 51 – 300 × 150

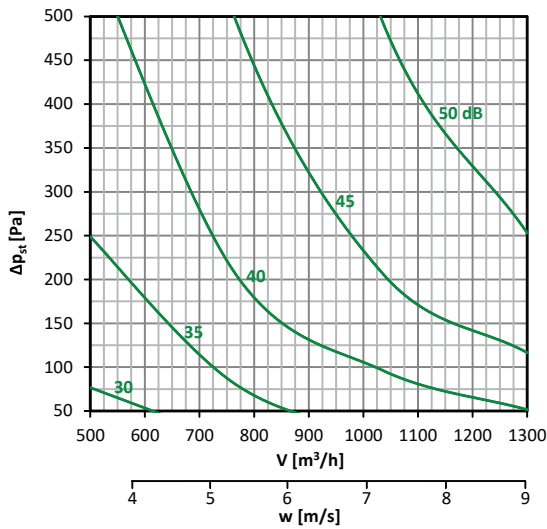

Diagramm nr. 52 – 300 × 200



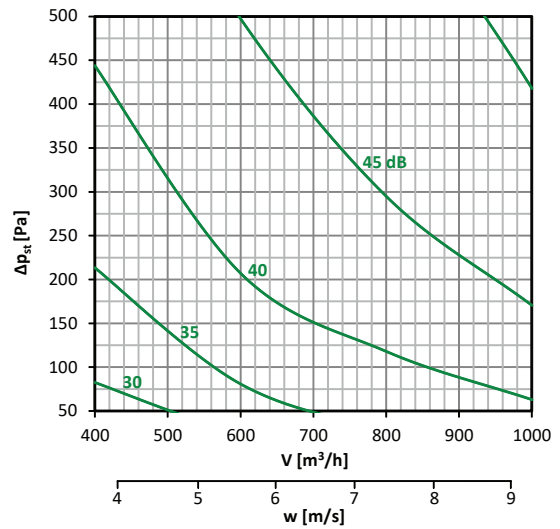

Diagramm nr. 53 – 300 × 250

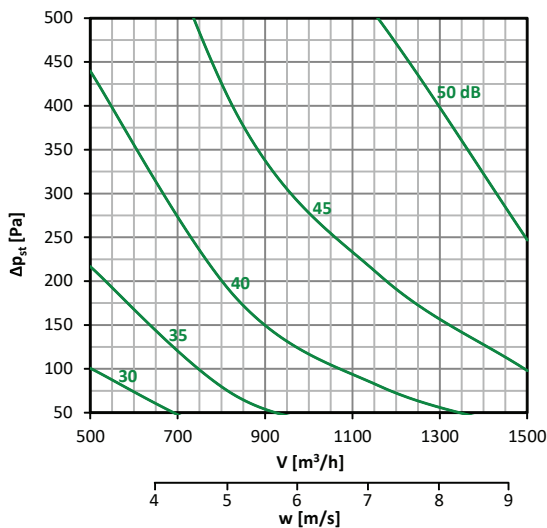

Diagramm nr. 54 – 300 × 300

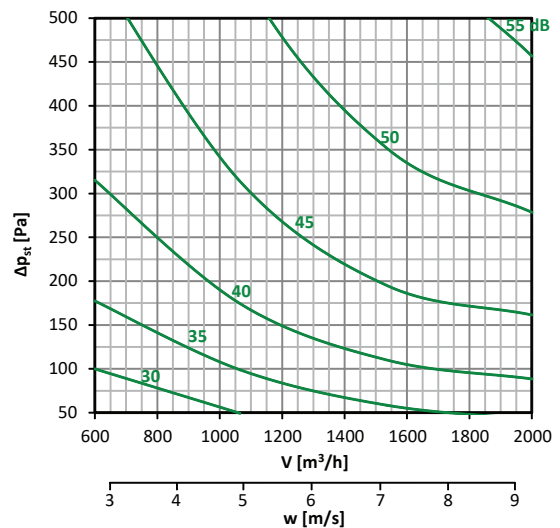

Diagramm nr. 55 – 400 × 200

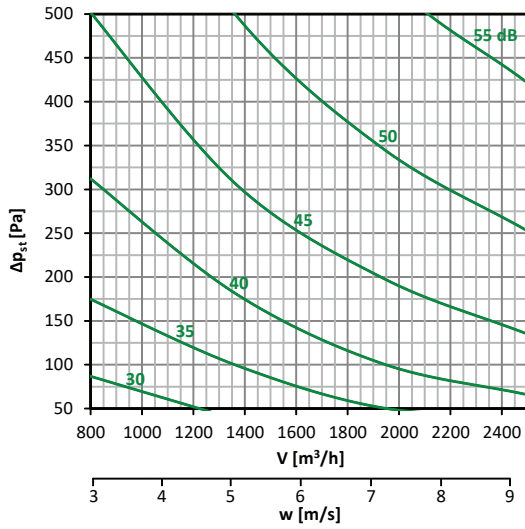

Diagramm nr. 56 – 400 × 250

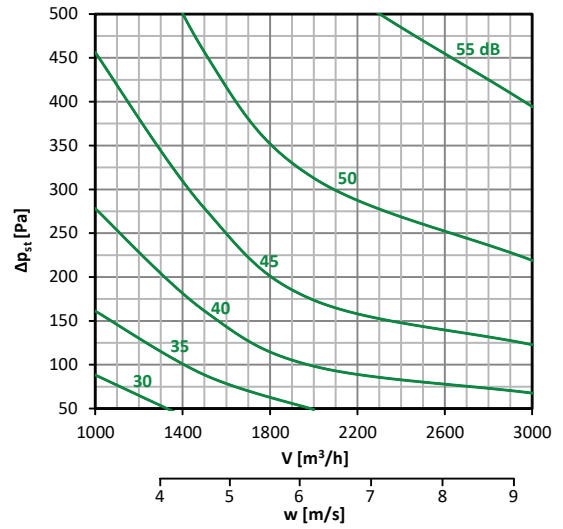

Diagramm nr. 57 – 400 × 300

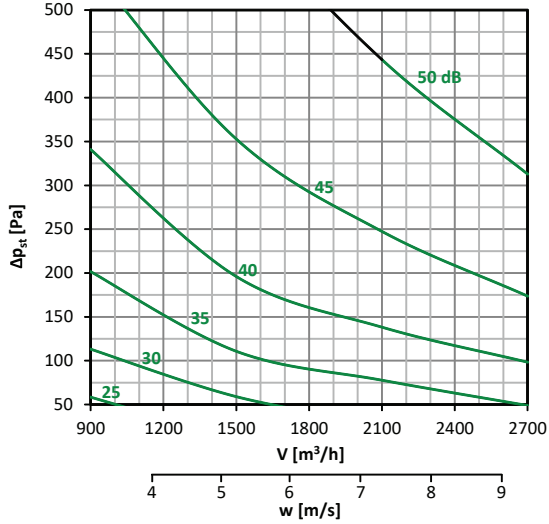

Diagramm nr. 58 – 400 × 400

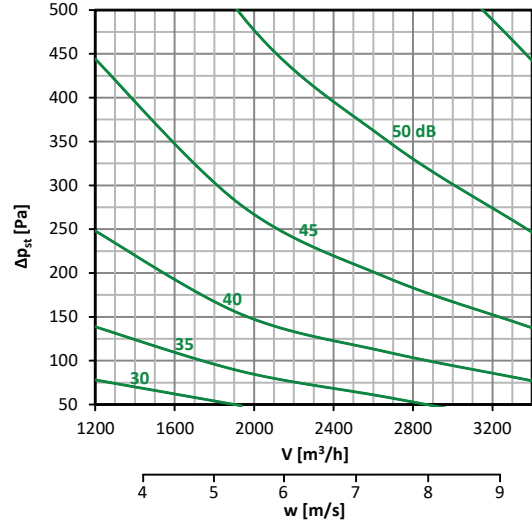

Diagramm nr. 59 – 500 × 200

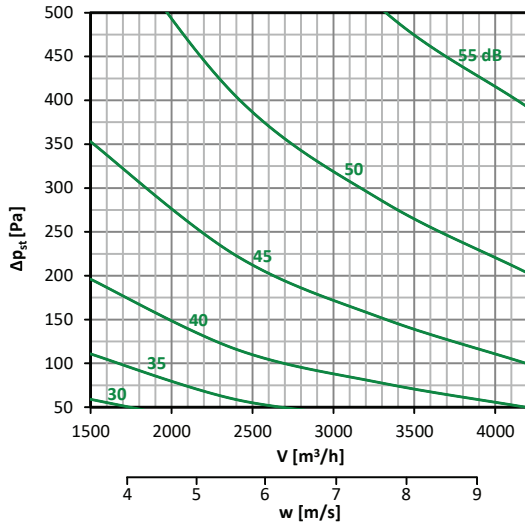

Diagramm nr. 60 – 500 × 250

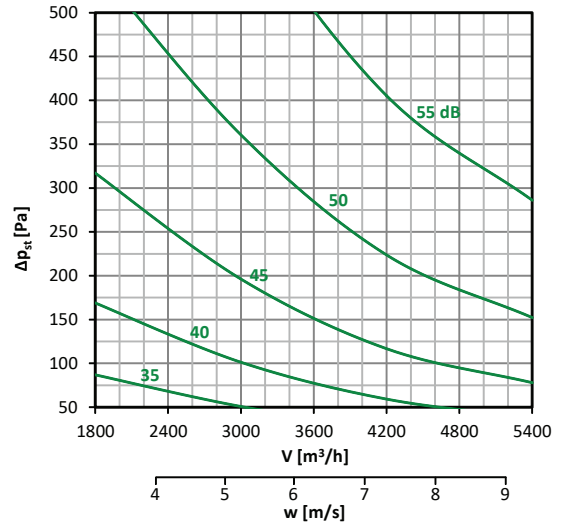

Diagramm nr. 61 – 500 × 300

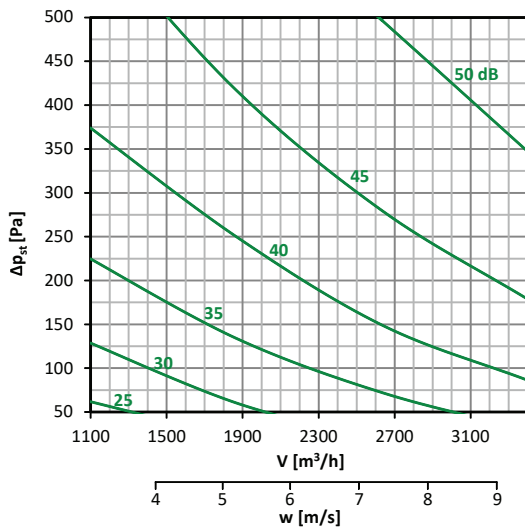

Diagramm nr. 62 – 500 × 400

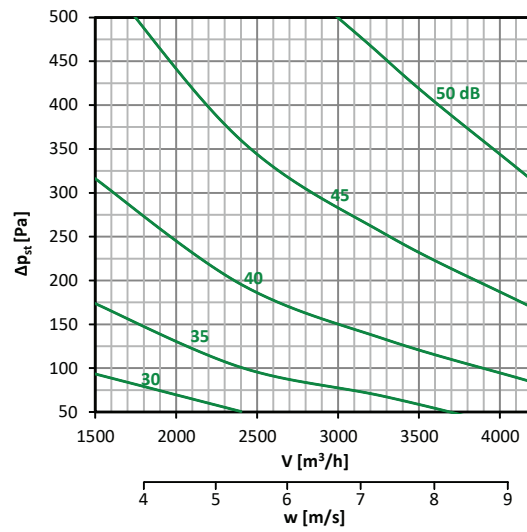

Diagramm nr. 63 – 500 × 500

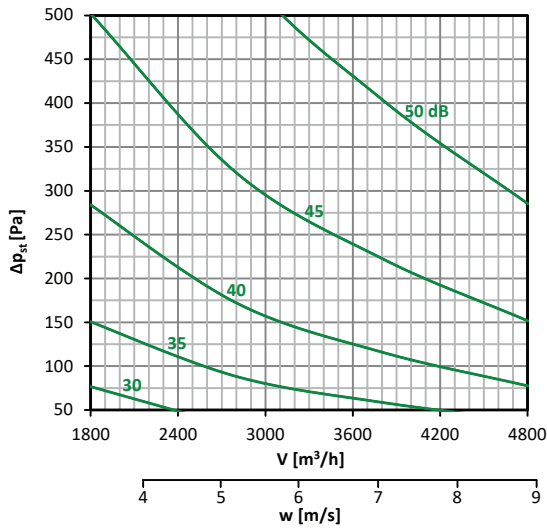

Diagramm nr. 64 – 600 × 200

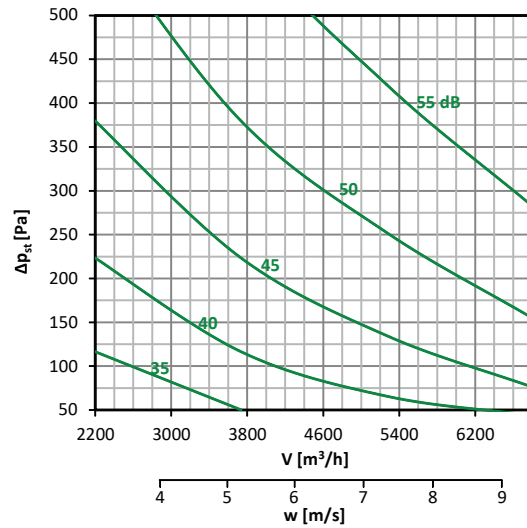

Diagramm nr. 65 – 600 × 250

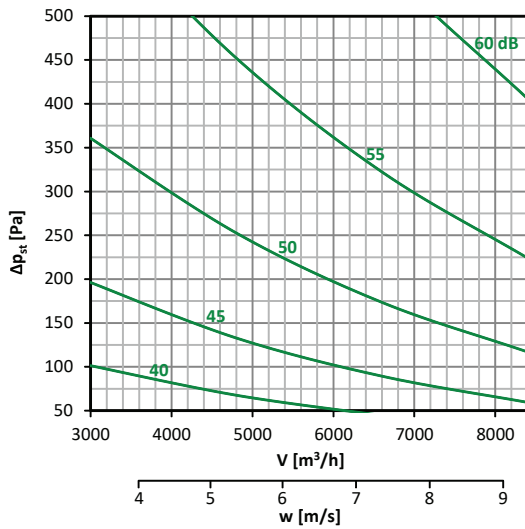

Diagramm nr. 66 – 600 × 300

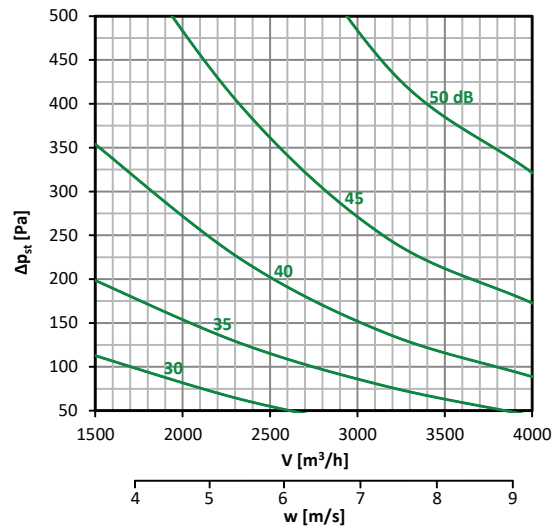

Diagramm nr. 67 – 600 × 400

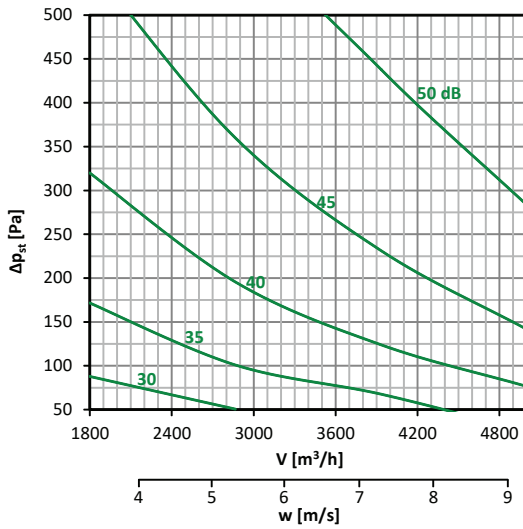

Diagramm nr. 68 – 600 × 500

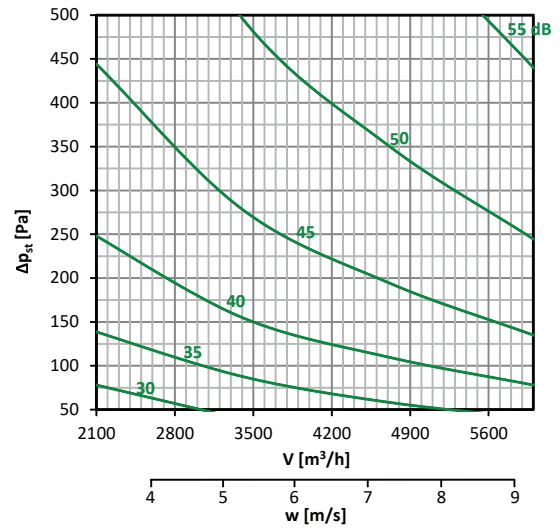

Diagramm nr. 69 – 600 × 600

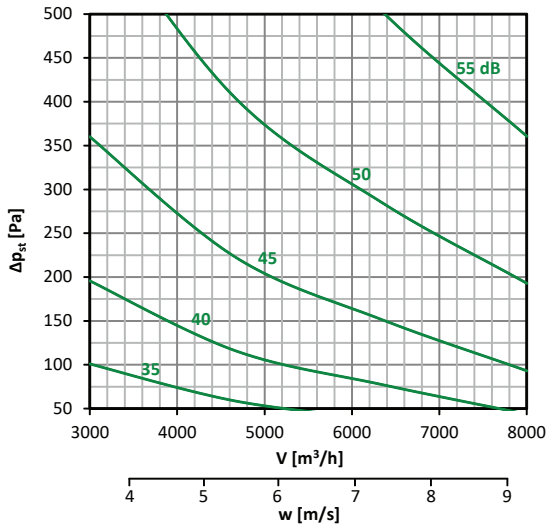

## 7. Kontrollimine ja testimine

Seadme on konstrueerinud ja eelseadistanud tootja, seadme töö sõltub nõuetekohasest paigaldusest ja reguleerimisest.

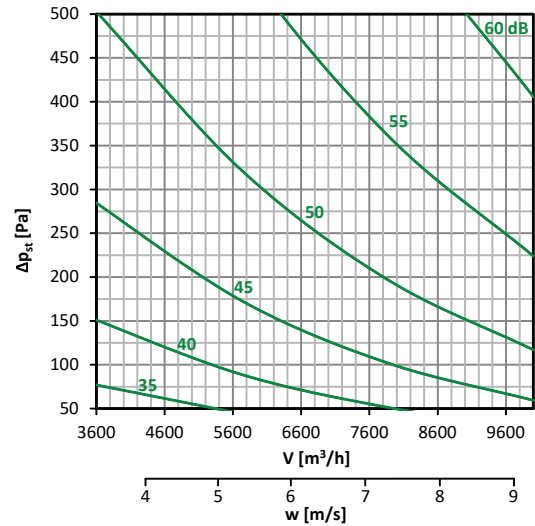
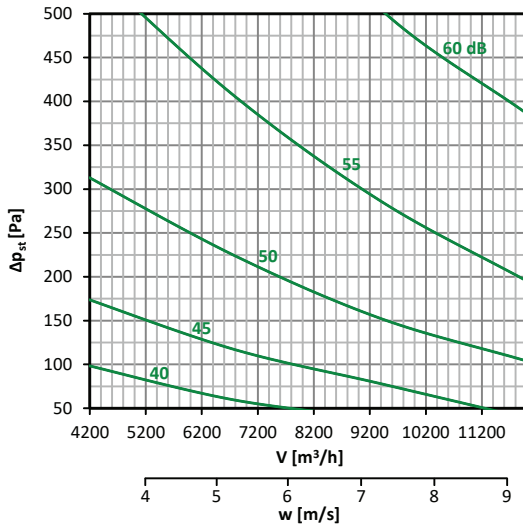
Kõik klapid on peale tootmist testitud vastavalt ohutuse ja toimivuse nõuetele..

## 8. Transport ja ladustamine

Klapid tuleb transpordida veokitega, kus puudub otsene ilmastikumõju ja seejuures ei esine äkilisi raputusi ning ümbritsev temperatuur ei ületa +40 °C. Transportimisel ja käsitlemisel tuleb klappid kaitsta mehaaniliste vigastuste eest. Transportimise ajal peab klapi laba olema asendis „SULETUD”.

Klappe tuleb hoida siseruumides, keskkonnas, kus ei ole agressiivseid aure, gaase ega tolmu. Sisetemperatuur peab olema vahemikus -5 °C kuni +40 °C ja maksimaalne suhteline niiskus 80%.

## 9. Markeerimine

RPMC-K 200 × 200 I .57

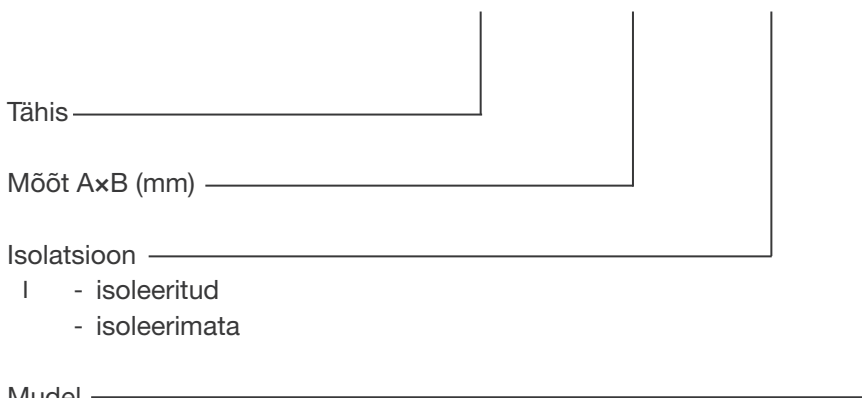

- Mudel
- .01 - manuaalne juhtimine
  - .45 - ajamiga juhtimine 230V, avatud-suletud
  - .46 - ajamiga juhtimine 230V, avatud-suletud, lõpplülitiga
  - .55 - ajamiga juhtimine 24V, avatud-suletud
  - .56 - ajamiga juhtimine 24V, avatud-suletud, lõpplülitiga
  - .57 - ajamiga juhtimine 24V SR sujuvjuhtimine

Näidis: RPMC-K 200 × 200 I .57



## ETS NORD AS

Address: Peterburi tee 53  
11415 Tallinn  
Estonia

Phone: +372 680 7360  
info@etsnord.ee  
www.etsnord.ee



*Let's move the air **together!***