

KRTS-4-T Reguleer- ja sulgklapp

KRTS-4-T tüüpi klappe kasutatakse ümarates madala või keskmise rõhu ja kiirusega suitsutorustikes õhuhulkade reguleer- ja sulgklapina.

KRTS-4-T on tihendatud reguleer- ja sulgklapp, mille korpusse tihendusklass vastab C ja klapi tihendusklass vastavalt standardile EVS-EN 1751:2014 klass 4 nõuetele.



Konstruksioon ja mõõdud

KRTS-4-T klapi korpus, laba ja mootorialus on valmistatud tsingitud teraslehest. Klapp on kanaliga ühendamiseks mõlemast otsast varustatud tihendiga.

Valmistame klappe ka tsink-magneesium kattega terasleht (ZM310).

Manuaalseks reguleerimiseks võimalik paigaldada käsi-juhtimishoob.

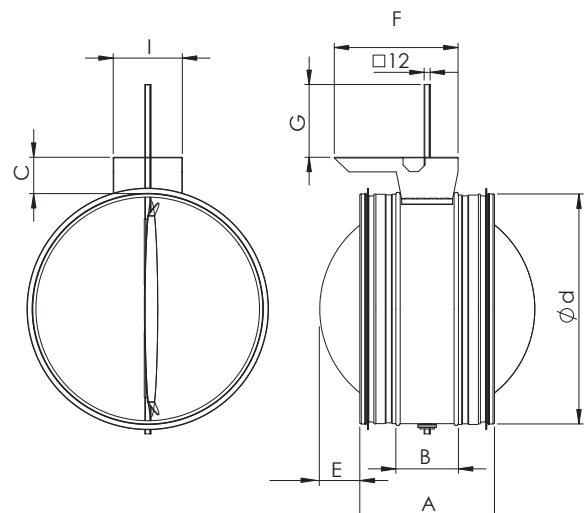

Nimimõõt Ød (mm)	A (mm)	B (mm)	C (mm)	E (mm)	F (mm)	G (mm)	I (mm)	Min pöördemoment (Nm)	Kaal (kg)
100	155	95	31	-	180	100	95	2	0,6
125	155	95	38	-	180	100	95	2	0,7
160	155	95	43	-	180	100	95	2	0,9
200	155	95	46	15	180	116	95	2	1,1
250	220	120	23	10	225	113	130	4	1,6
315	220	120	31	43	225	110	130	4	2,1
400	220	120	36	85	225	109	130	4	3,2
500	255	130	40	115	225	108	130	10	4,7
630	255	130	43	180	225	107	130	10	6,3

Tehnilised andmed

KRTS-4-T, laba tihedusklass 4

KRTS-4-T 100

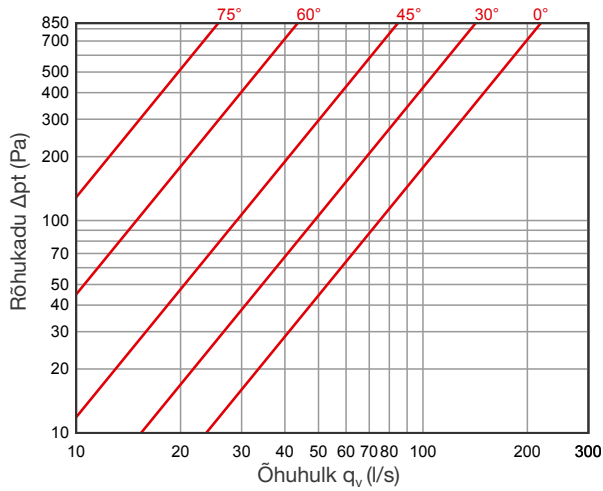

KRTS-4-T 125

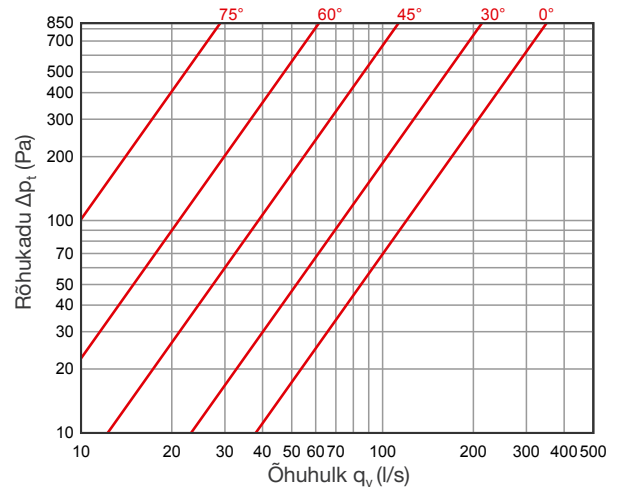

KRTS-4-T 160

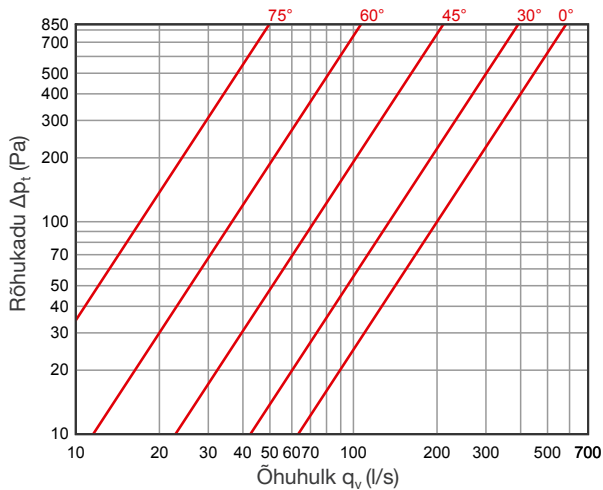

KRTS-4-T 200

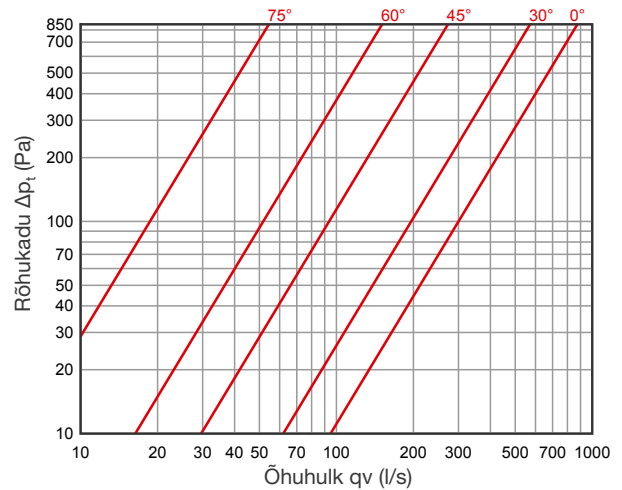

KRTS-4-T 250

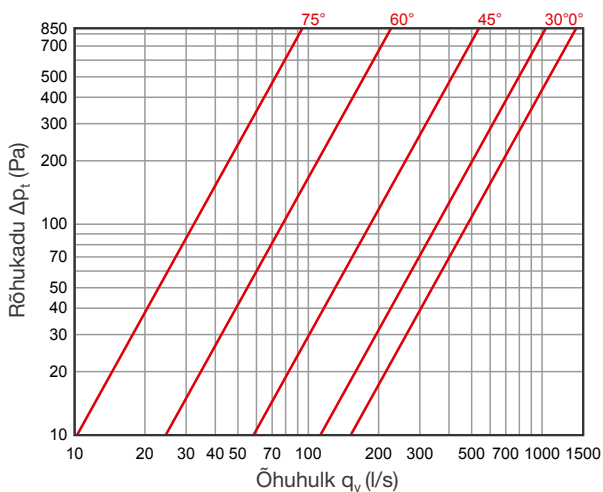

KRTS-4-T 315

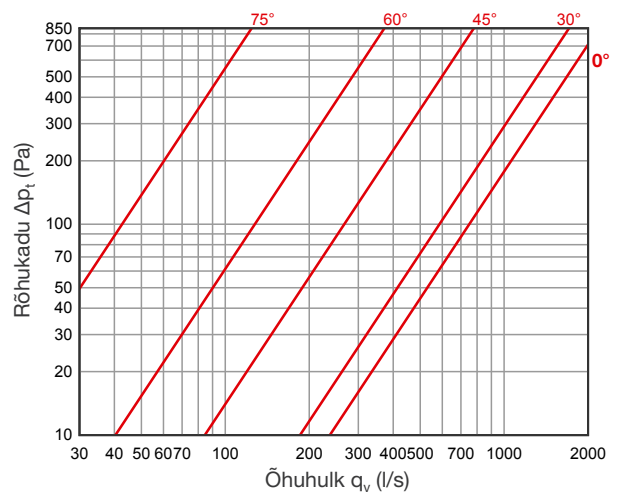

KRTS-4-T 400

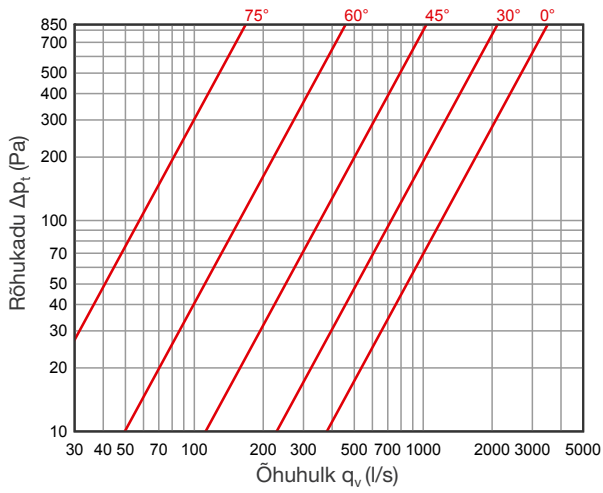

KRTS-4-T 500

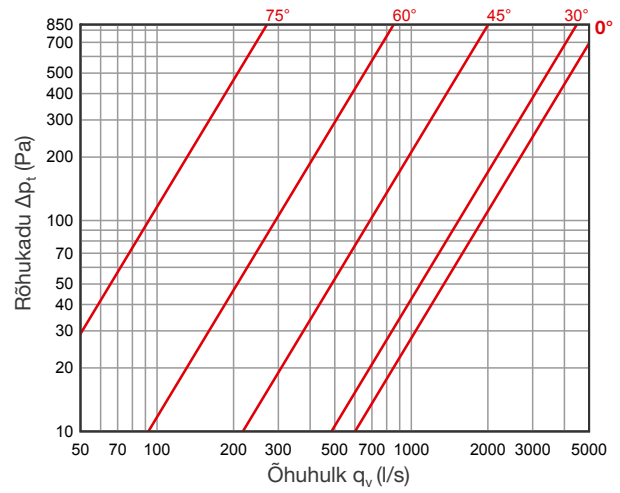

KRTS-4-T 630

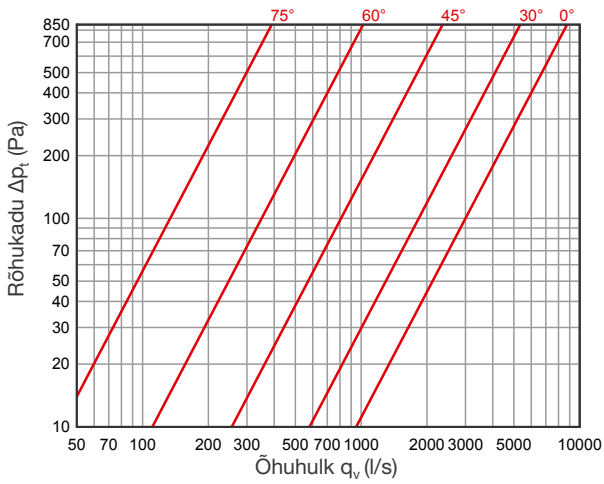

Markeerimine

KRTS-4-T - ZM - d

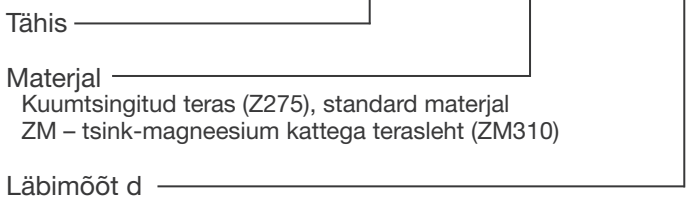

Näidis: KRTS-4-T 315