

KRI-T Mõõte- ja reguleerklapp

KRI-T sobib õhuhulkade täpseks ja kiireks mõõdistamiseks ning seadistamiseks.

KRI-T klapi korpus vastab C tihedusklassi nõuetele.

Konstruksioon ja mõõdud

KRI-T koosneb raamiosast, klapilabadest, reguleerimutrist, skaalast ja mõõteotsikutest.

Seadme raamiosa ja labad on valmistatud kuumtsingitud terasplekist, teised osad nagu reguleermutter ja mõõteotsikud aga plastikust.

Ühendusliitmikud on varustatud tihendiga.



Nimimõõt Ød (mm)	ØD (mm)	l (mm)	L (mm)	Kaal (kg)
KRI-T 100	160	58	198	0,8
KRI-T 125	185	58	198	1,0
KRI-T 160	225	60	200	1,4
KRI-T 200	280	70	210	1,8
KRI-T 250	330	63	285	2,7
KRI-T 315	405	63	287	3,5
KRI-T 400	525	44	274	8,1
KRI-T 500	655	55	325	12,1
KRI-T 630	815	55	325	18,7
KRI-T 800	1015	70	270	28,0

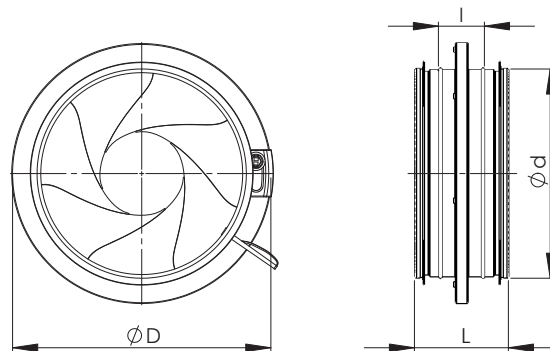

Tehnilised andmed

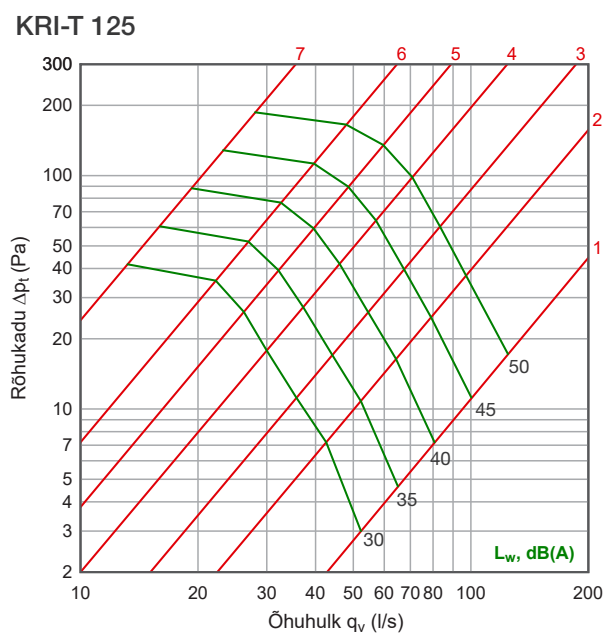
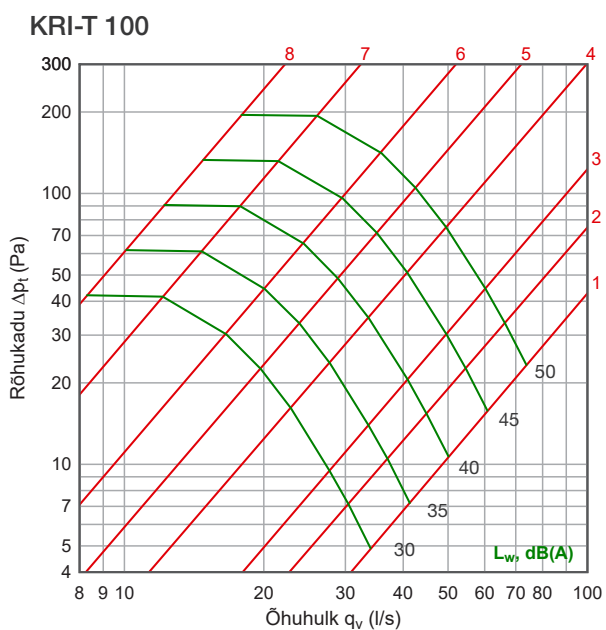

KRI-T 160

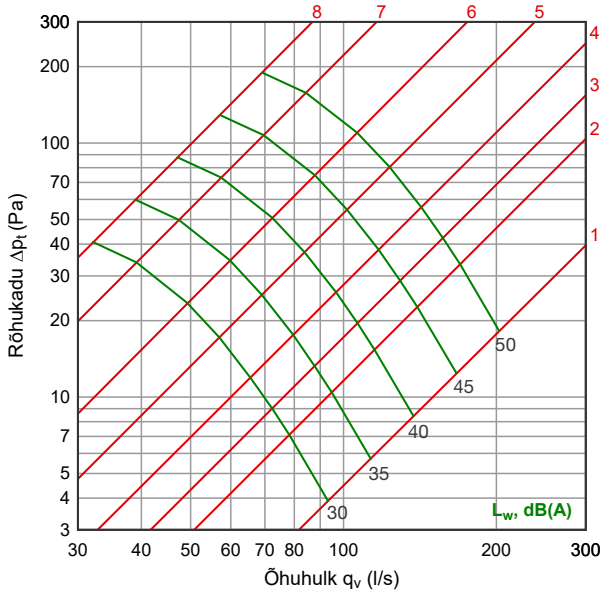

KRI-T 200

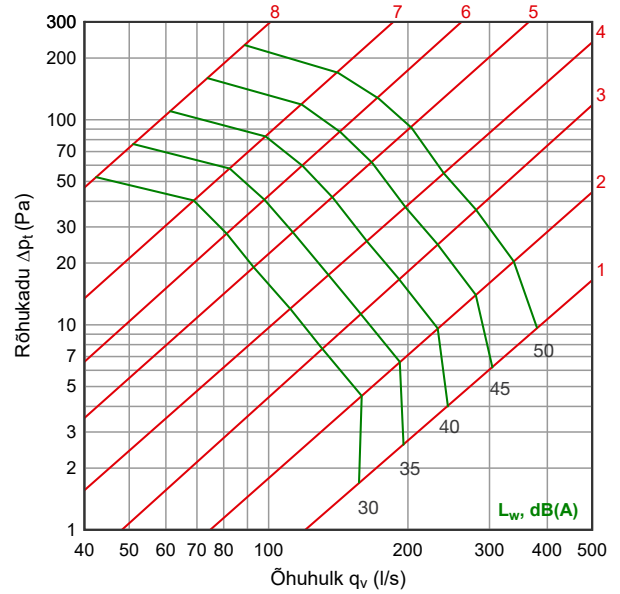

KRI-T 250

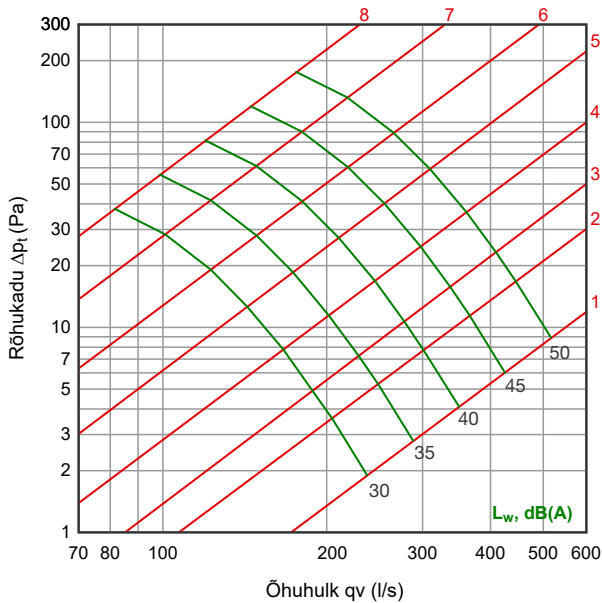

KRI-T 315

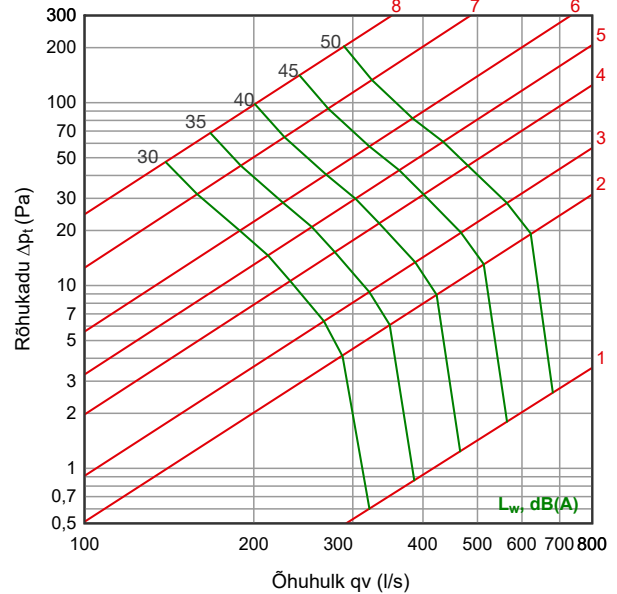

KRI-T 400

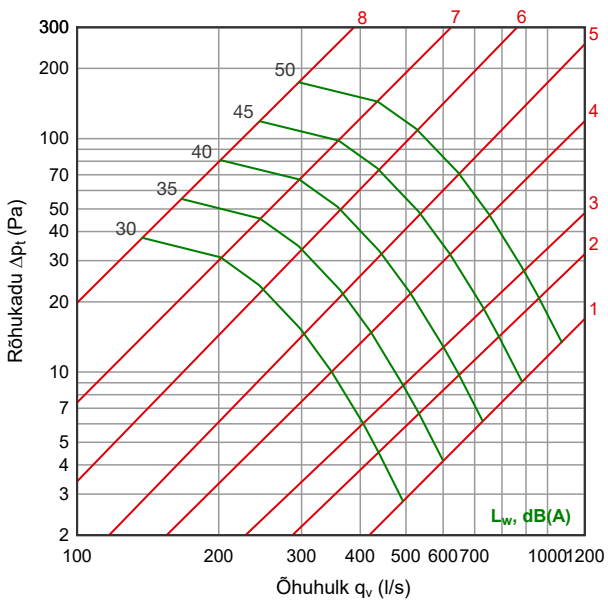

KRI-T 500

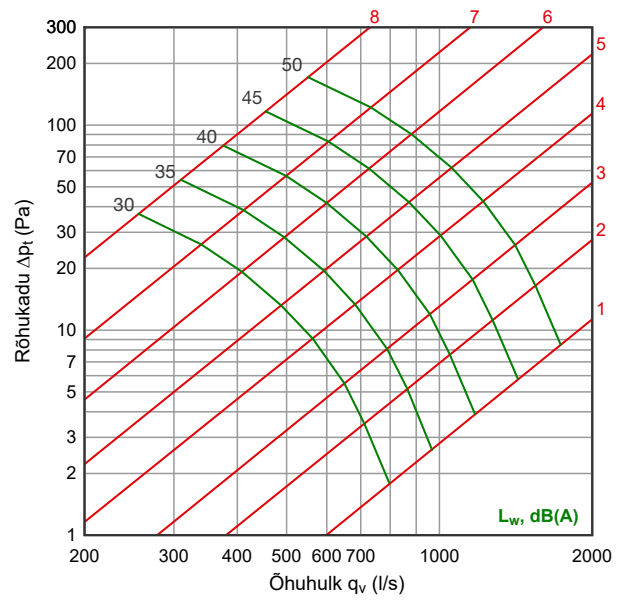

KRI-T 630

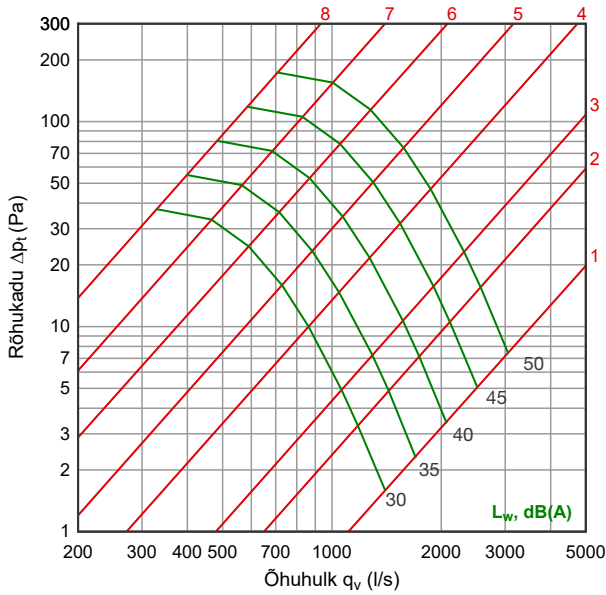

KRI-T 800

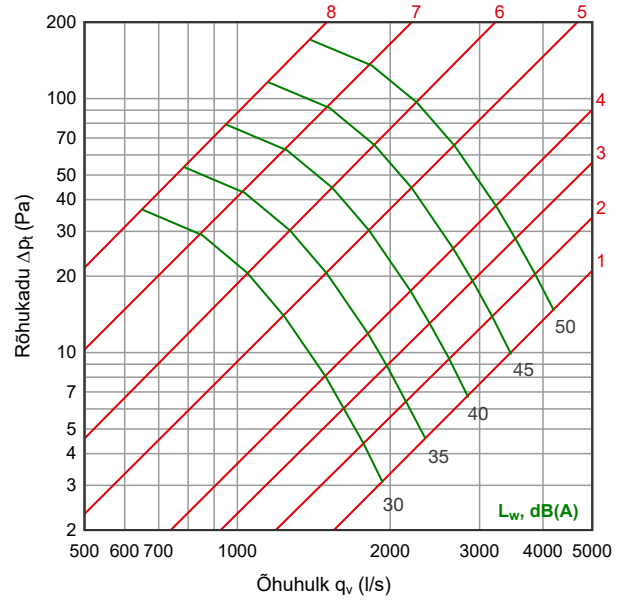

Müra andmed L_w

	Müravõimsuse parandustegur K_{okt} [dB]							
	63	125	250	500	1000	2000	4000	8000
KRI-T 100	8	7	4	-3	-8	-15	-18	-25
KRI-T 125	9	7	3	-3	-8	-13	-18	-24
KRI-T 160	11	9	4	-3	-9	-12	-18	-25
KRI-T 200	14	9	3	-3	-9	-11	-18	-25
KRI-T 250	16	10	2	-4	-8	-12	-21	-26
KRI-T 315	19	10	2	-5	-7	-14	-23	-26
KRI-T 400	19	8	2	-3	-8	-15	-22	-26
KRI-T 500	19	6	3	-2	-9	-15	-20	-25
KRI-T 630	20	8	2	-3	-9	-15	-20	-26
KRI-T 800	21	9	2	-4	-10	-15	-20	-27
Tolerants \pm	4	4	4	4	4	4	4	4

Müravõimsustase kanalis oktaavriba kesksagedusel saadakse lisades kogu helirõhutasemele (L_{p10A} [dB(A)]) tabelis antud müravõimsuse parandustegur oktaavribakesksagedusel (K_{okt}) alljärgneva valemi abil:

$$L_{W_{okt}} = L_{p10A} + K_{okt}$$

Müravõimsuse parandustegur K_{okt} on keskmine väärtus reguleerklapi mõõtepiirkonnas.

Suitsutõkkeomadused

KRI-100 ja KRI-125 täidavad RakMK E7:2004 suitsuklapilt nõutud omadused (42 dm³/s, 100 Pa), juhul kui KRI-100 asend on $\geq 6,0$ ja KRI-125 asend on $\geq 5,5$.

Markeerimine

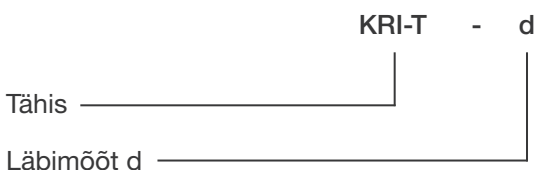

Näidis: KRI-T 100