

## RVUK External louvre

External louvre with electric heating for aggressive weather conditions.

- With labyrinth structure
- Good resistance in stormy weather
- Removable front and back louvres
- Back louvre equipped with self-regulating thermal cable (operating voltage 230 V)

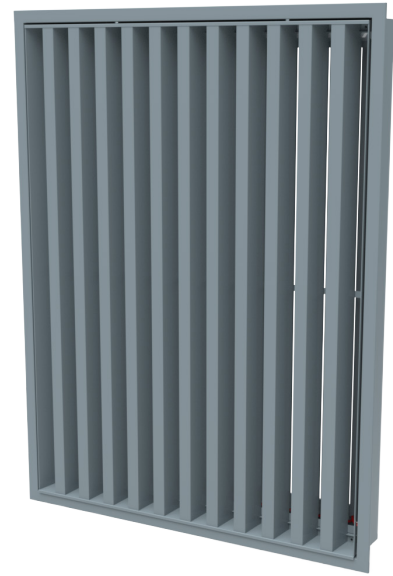

### Operation

The front louvre distributes air flow evenly on the grille. Snow trapped to the back louvre melts and flows along the grille surface to a draining pipe. The draining pipe can be connected to drainage (drainage connection R3/4" with outer thread).

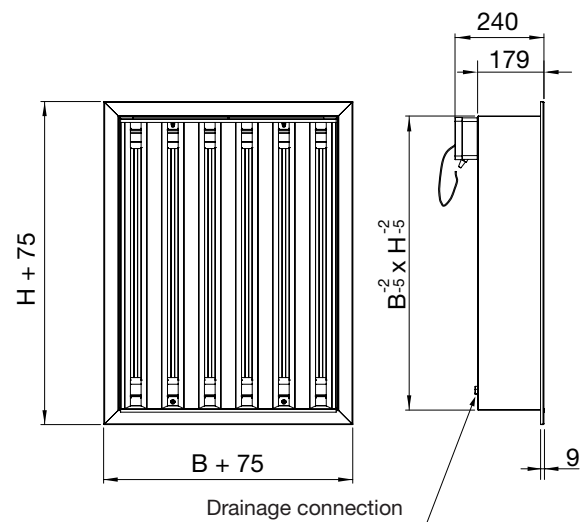

### Structure and dimensions

RVUK external louvre has 3 structural parts:

1. front louvre
2. back louvre
3. mounting frame

Front louvre and mounting frame are manufactured of galvanized steel sheet and powder coated (standard colour RAL 7000). Back louvre is manufactured of aluminium profiles and is equipped with a self-regulating thermal cable (ELSR N-40-2-AO (Eltherm)).

Can also be manufactured of aluminium, stainless steel or acid-proof steel.

Can be produced for all sizes of openings.

Standard sizes every 100 mm. Minimum size 500x500 mm. The area of the maximum size manufactured in one part is 1,0 m<sup>2</sup>. Larger units are manufactured in modules with a connection box in each module.

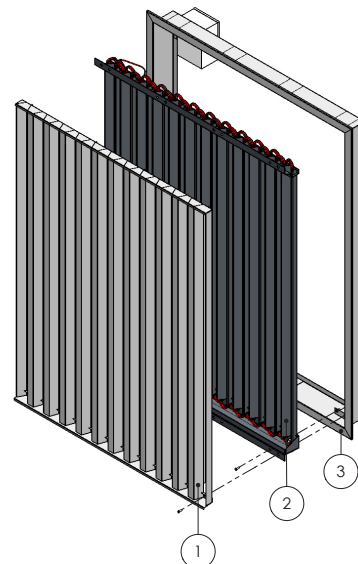

Pressure drop

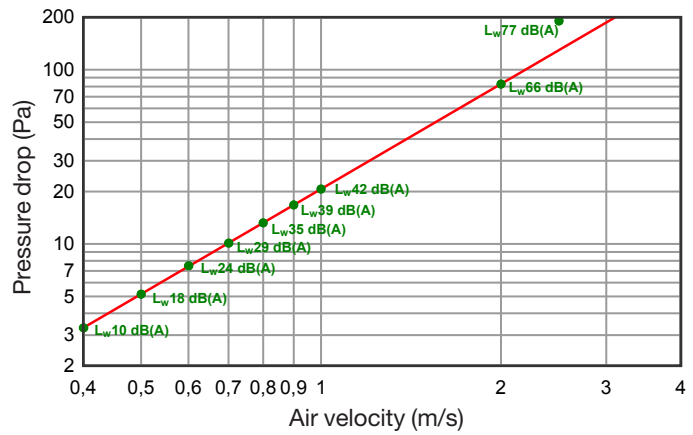

Heating power

RVUK louver maximum heating power of the thermal cable is 2100 W/m<sup>2</sup> (16A), when outside temperature is -18 °C.

Operating voltage 230 VAC / 50 Hz. Each module is connected to the louver separately under 16A fuse.

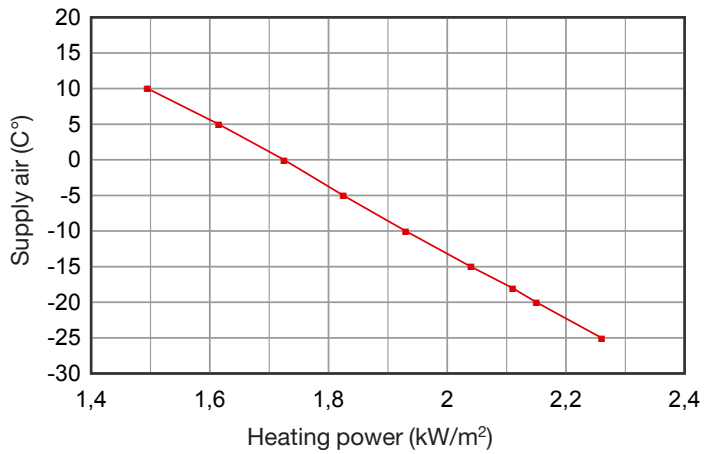

RVUK Resistance to water penetration

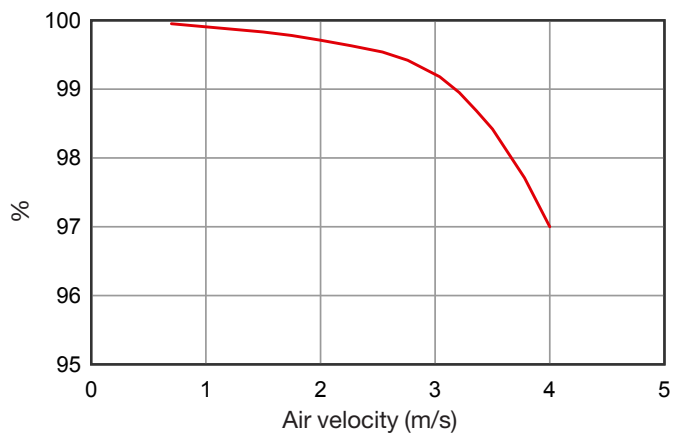

**Product marking**

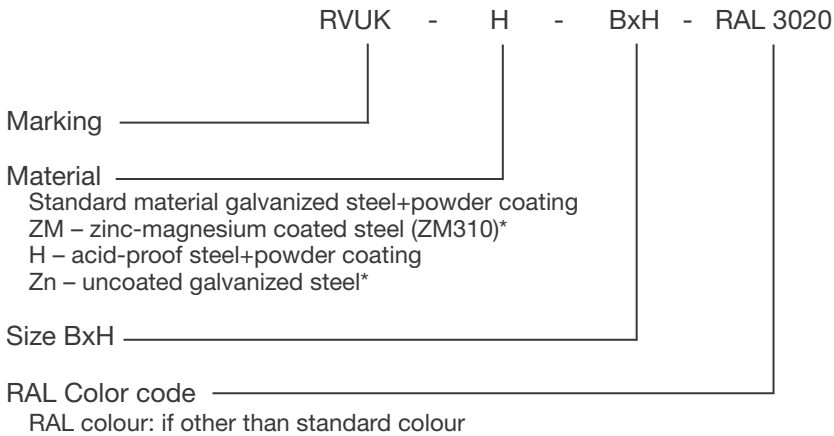

\* Rust warranty does not apply.

**Example: RVUK 1200x1000**

**Installation instructions**

First fix the mounting frame. Mounting frame dimensions are 5 mm smaller than the unit's nominal dimensions. Then install the back louvre and front louvre to the frame with screws.

For electrical and drainage connections, at least 100 mm free space must be left behind the unit.

Drainage pipe with sewer connection 1/2" x 3/8" with outer thread.

**Electrical connection**

Electrical connections shall be made in IP65 connection box (included). In the modular construction there is a separate connection box in each module. Every module has to be connected separately under 16A fuse. This must be taken into account when electrical drawings are being drafted.

