

KROS Injusteringspjäll

Injusteringspjäll för runda kanalsystem.

- Steglös justering
- Tar liten plats
- Lätt att installera
- Tätningsprofiler EPDM
- Täthetsklass enligt EN 1751, klass D



Uppbyggnad och dimensioner

Tillverkad av galvaniserad stålplåt med tätningsprofiler i EPDM (max 150°C).
Manuell injustering.

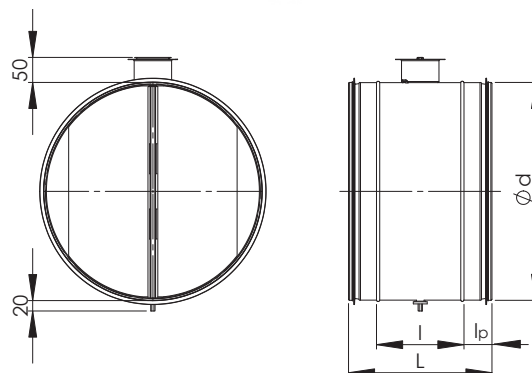

Nominell dimension, d mm	l, mm	l _p , mm	L, mm	Vikt, kg
80	95	30	155	0,29
100	95	30	155	0,35
125	95	30	155	0,45
160	95	30	155	0,6
200	120	50	220	0,8
250	120	50	220	1,3
315	120	50	220	1,8
400	133	61	255	3,0
500	133	61	255	4,4
630	130	65	255	6,0

Teknisk data

KROS 100

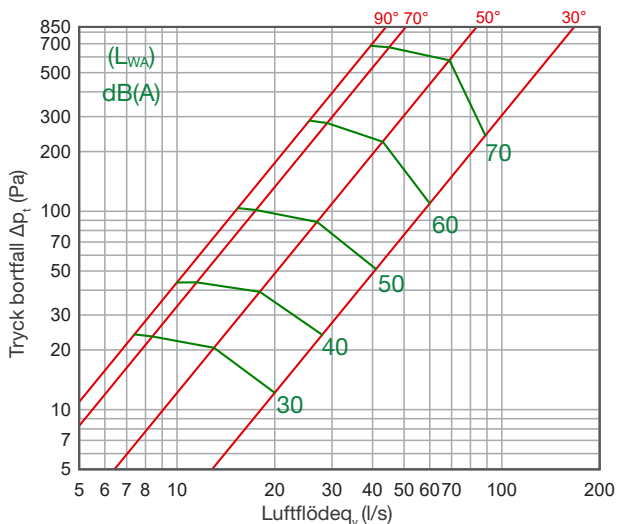

KROS 125

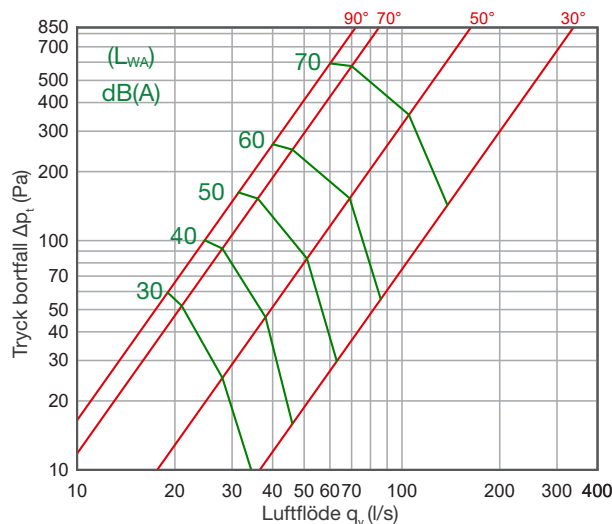

KROS 160

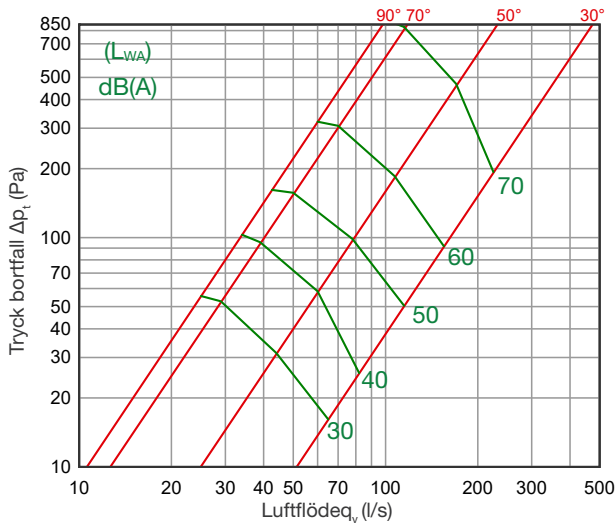

KROS 200

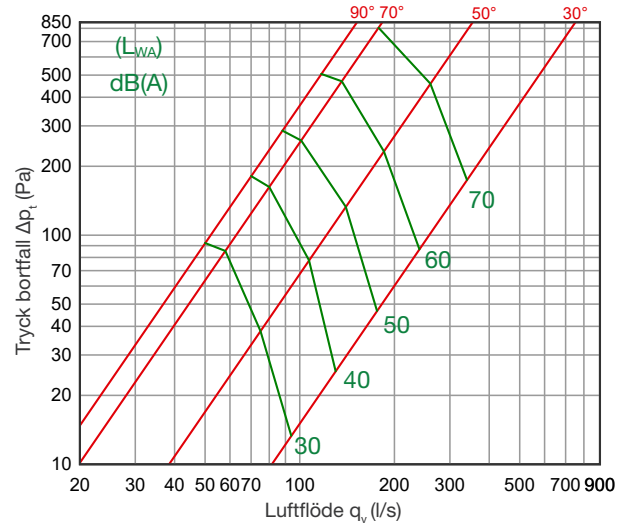

KROS 250

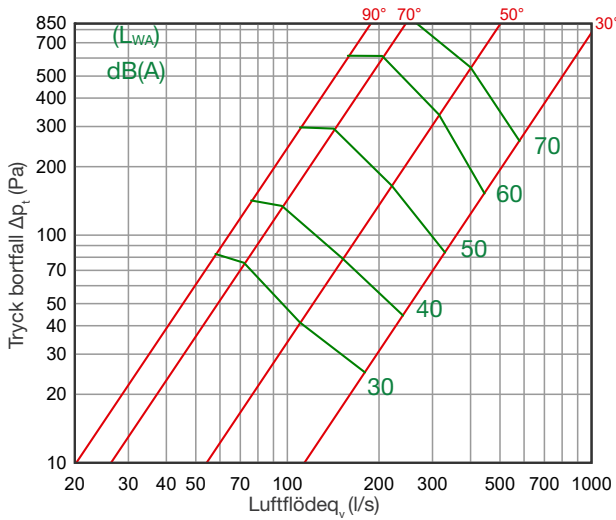

KROS 315

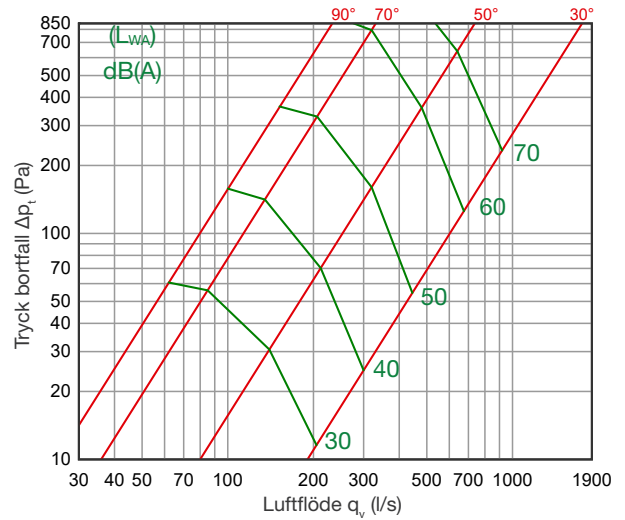

KROS 400

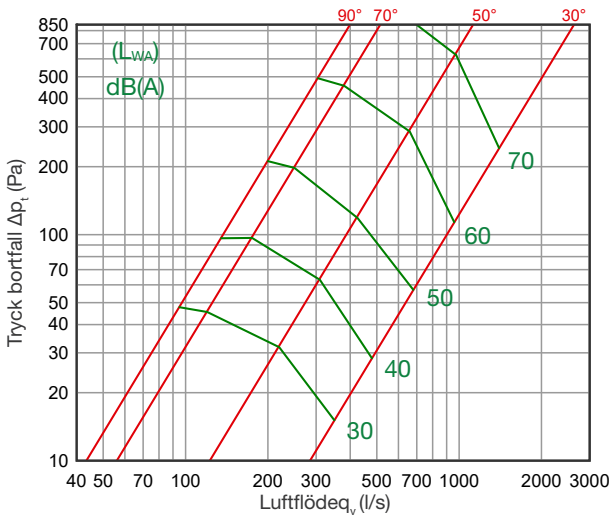

KROS 500

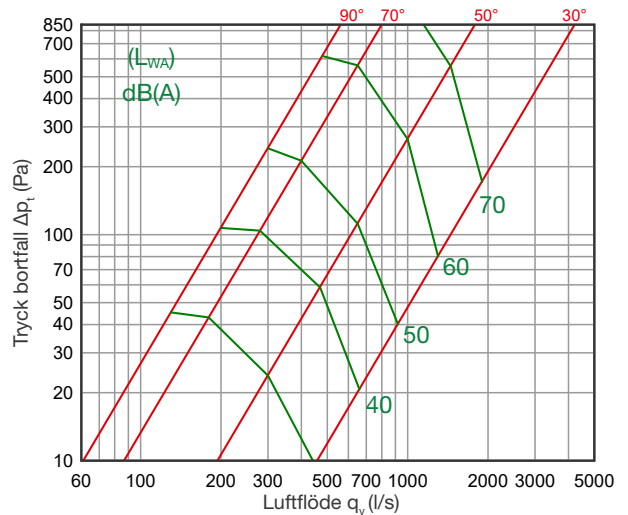

KROS 630

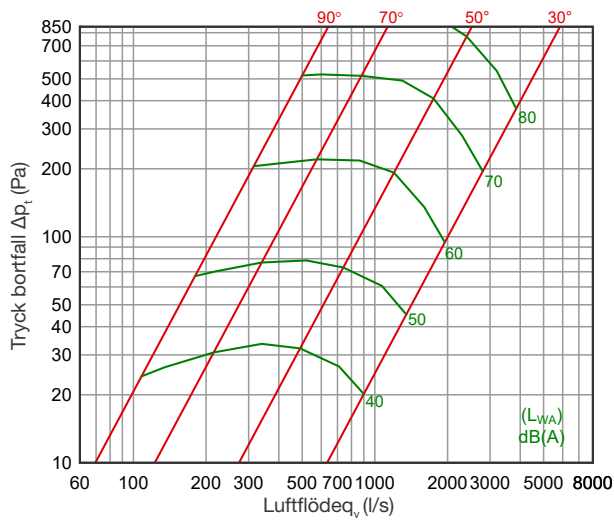

Markering

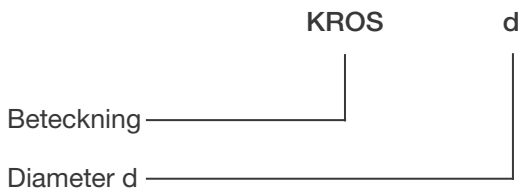

Exempel: KROS 315

Installation

Installeras enligt NORDduct installations guide.