

**NV Bend**

Ventilation system bend, consists of rolled sectors.  $r=1*d$ .

**NV 90°**

| Nominal size d | l (mm) | l <sub>p</sub> (mm) | Weight (kg) |
|----------------|--------|---------------------|-------------|
| 250            | 250    | 50                  | 1,7         |
| 315            | 315    | 50                  | 3,6         |
| 400            | 400    | 50                  | 6,9         |
| 500            | 500    | 61                  | 10,1        |
| 630            | 630    | 61                  | 15,0        |
| 800            | 800    | 96                  | 27,0        |
| 1000           | 1000   | 110                 | 47,0        |
| 1250           | 1250   | 110                 | 64,0        |
| 1600           | 1600   | 110                 | 116,0       |

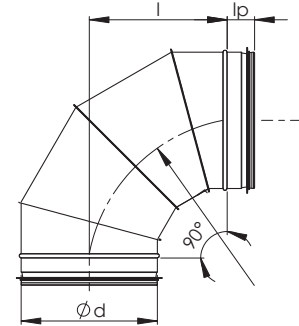

**NV 60°**

| Nominal size d | l (mm) | l <sub>p</sub> (mm) | Weight (kg) |
|----------------|--------|---------------------|-------------|
| 250            | 146    | 50                  | 2,2         |
| 315            | 184    | 50                  | 3,0         |
| 400            | 234    | 50                  | 4,6         |
| 500            | 292    | 61                  | 6,1         |
| 630            | 367    | 61                  | 9,3         |
| 800            | 466    | 96                  | 15,6        |
| 1000           | 583    | 110                 | 29,0        |
| 1250           | 728    | 110                 | 36,0        |
| 1600           | 932    | 110                 | 83,0        |

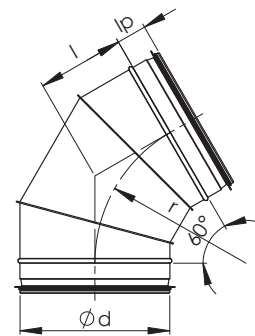

**NV 45°**

| Nominal size d | l (mm) | l <sub>p</sub> (mm) | Weight (kg) |
|----------------|--------|---------------------|-------------|
| 250            | 105    | 50                  | 1,1         |
| 315            | 130    | 50                  | 2,2         |
| 400            | 165    | 50                  | 3,7         |
| 500            | 205    | 61                  | 5,1         |
| 630            | 260    | 61                  | 7,7         |
| 800            | 330    | 96                  | 15,0        |
| 1000           | 415    | 110                 | 24,0        |
| 1250           | 520    | 110                 | 34,0        |
| 1600           | 665    | 110                 | 63,0        |

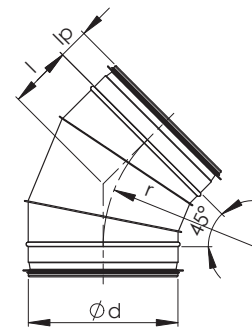

**NV 30°**

| Nominal size d | l (mm) | l <sub>p</sub> (mm) | Weight (kg) |
|----------------|--------|---------------------|-------------|
| 250            | 70     | 50                  | 0,8         |
| 315            | 85     | 50                  | 1,7         |
| 400            | 110    | 50                  | 3,4         |
| 500            | 135    | 61                  | 3,7         |
| 630            | 170    | 61                  | 5,6         |
| 800            | 215    | 96                  | 11,0        |
| 1000           | 270    | 110                 | 17,0        |
| 1250           | 335    | 110                 | 26,0        |

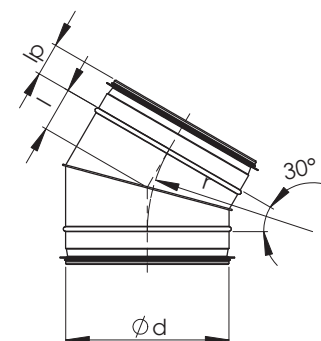

**NV 15°**

| Nominal size<br>d | l<br>(mm) | l <sub>p</sub><br>(mm) | Weight<br>(kg) |
|-------------------|-----------|------------------------|----------------|
| 250               | 33        | 50                     | 0,75           |
| 315               | 51        | 50                     | 1,1            |
| 400               | 53        | 50                     | 1,9            |
| 500               | 66        | 61                     | 2,4            |
| 630               | 83        | 61                     | 3,3            |
| 800               | 105       | 96                     | 7,5            |
| 1000              | 132       | 110                    | 13,0           |
| 1250              | 165       | 110                    | 17,0           |

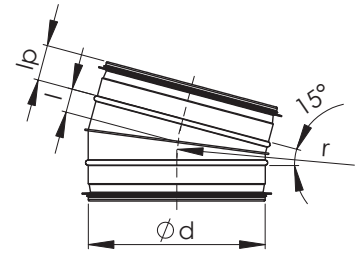
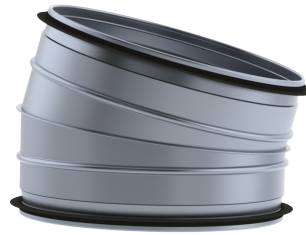

**Product codes**

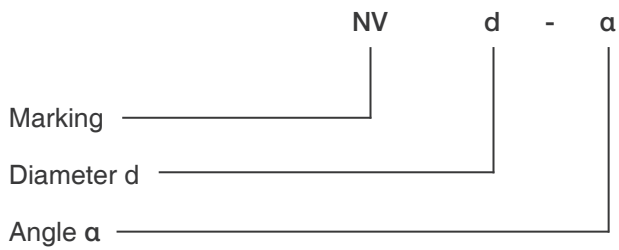

Example: NV 315-90