

NVP Käyrä

$r=1*d$

NVP 90°

Nimellismitta d (mm)	l (mm)	l _p (mm)	Paino (kg)
80	80	35	0,3
100	100	30	0,35
125	125	30	0,46
160	160	30	0,83
200	200	30	1,27

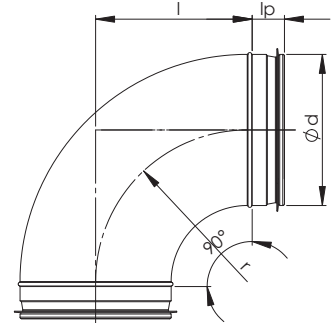

NVP 60°

Nimellismitta d (mm)	l (mm)	l _p (mm)	Paino (kg)
80	46	35	0,3
100	58	30	0,4
125	72	30	0,5
160	92	30	0,7
200	115	30	0,95

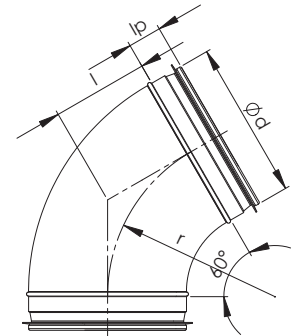

NVP 45°

Nimellismitta d (mm)	l (mm)	l _p (mm)	Paino (kg)
80	40	35	0,2
100	40	30	0,24
125	51	30	0,34
160	65	30	0,52
200	80	30	0,77

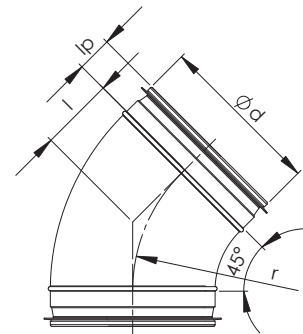

NVP 30°

Nimellismitta d (mm)	l (mm)	l _p (mm)	Paino (kg)
100	27	30	0,2
125	33	30	0,27
160	43	30	0,4
200	54	30	0,65

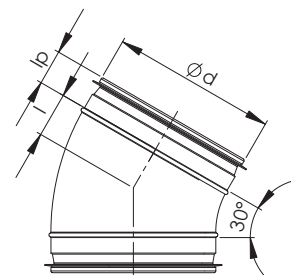

NVP 15°

Nimellismitta d (mm)	l (mm)	l _p (mm)	Paino (kg)
80	11	35	0,13
100	13	30	0,17
125	16	30	0,25
160	21	30	0,45
200	26	30	0,5

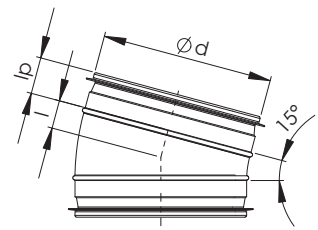

Tuotemerkintä

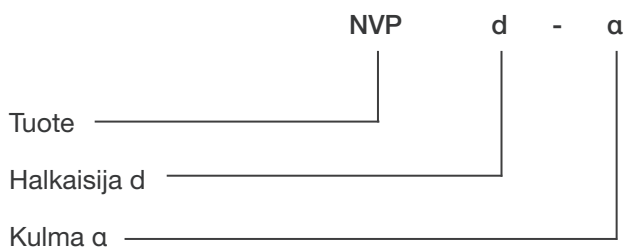

Esimerkki: NVP 200-90