

**DEN paigaldus • installation • asennus**

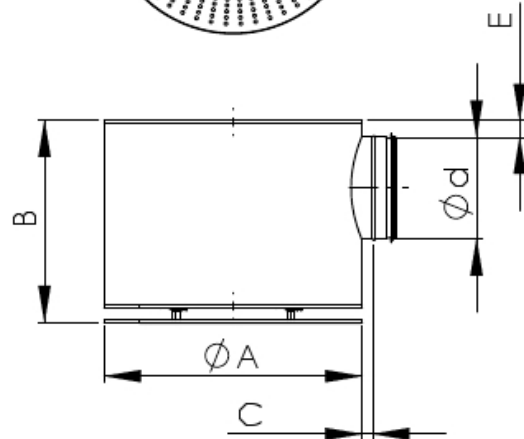

Nominal size	A	B	E
100	350	230	36
125	350	230	38
160	400	265	41
200	400	295	31
250	500	385	56
315	600	480	56

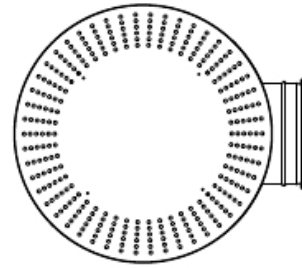
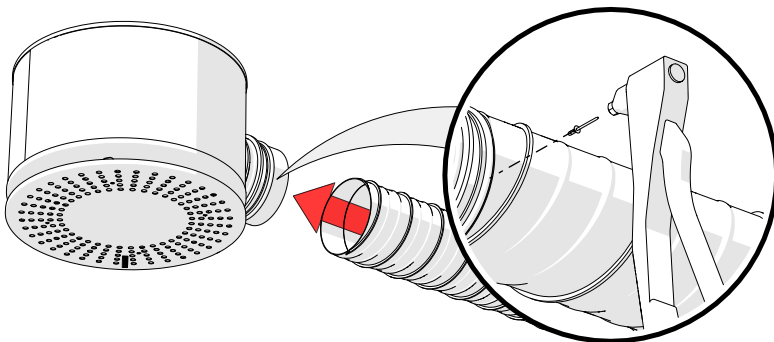

Ød (mm)	Rivet (pcs)
100-250	3
315	4

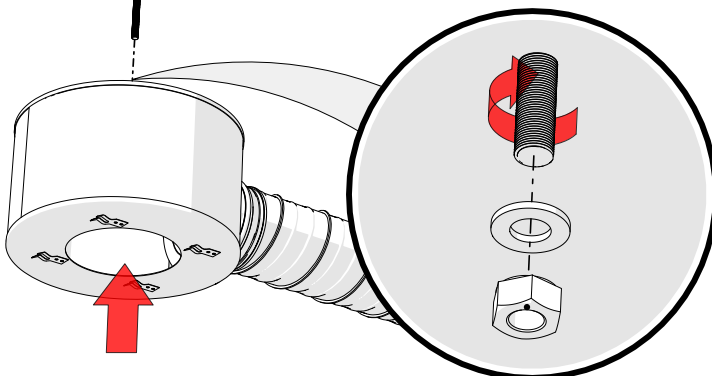
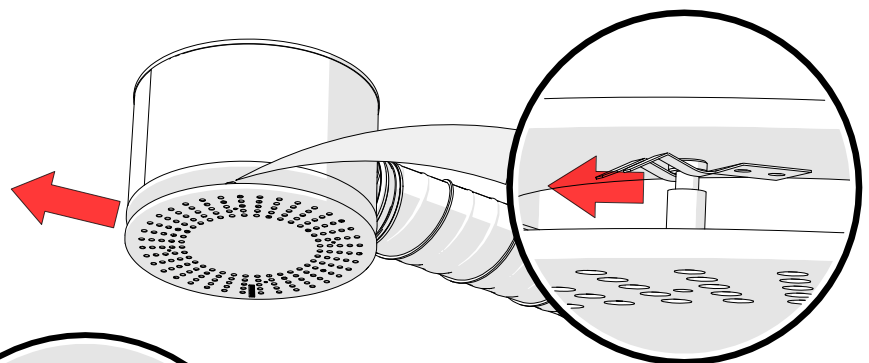

# DEN paigaldus • installation • asennus

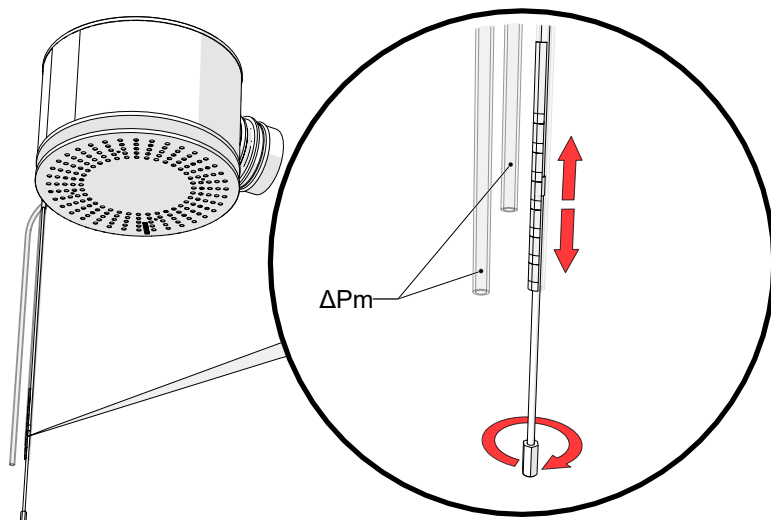

$$Q_v = k * \sqrt{\Delta p_m} \text{ (l/s)}$$

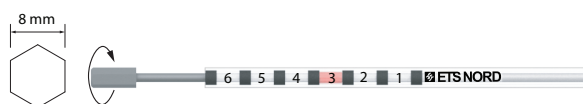

## DEN k-value

Nominal size	Position							
	1	2	3	4	5	6	7	8
DEZ 100	2,2	3,7	5,4	6,7				
DEZ 125	1,9	3,7	5,4	7,3	8,6	9,8		
DEZ 160	3,3	5,6	9,1	13,0	14,7	17,0		
DEZ 200	5,2	10,0	15,1	21,3	26,1	29,3		
DEZ 250	8,7	16,6	24,2	33,7	40,6	43,5		
DEZ 315	7,8	18,0	27,9	36,1	47,5	56,5	86,4	91,3

